

# QUARANTA5

DESIGN EDITION

# QUARANTA5

DESIGN EDITION

QUARANTA5, forme pure e volumi compatti. Unioni perfette tra ante, top e fianchi, con taglio a 45 gradi, nessuno spessore a vista. Una comoda maniglia trapezoidale incavata nel frontale diventa elemento ornamentale e funzionale per le aperture. Disponibile in legno su multistrati di betulla o laccato su mdf.

QUARANTA5: simple lines and compact shapes. The joins between the doors, tops and side panels are perfectly neat and feature a 45° cut creating no visible depth. The practical trapezoid handle carved into the front is both decorative and functional for opening the drawers. Available in a wood finish on birch plywood or a lacquered finish on MDF.

QUARANTA5, des formes pures et des volumes compacts. Unions parfaites entre portes, plans de travail et côtés, avec découpe à 45°, aucune épaisseur visible. Une pratique poignée trapézoïdale obtenue dans la façade devient un élément ornemental et fonctionnel pour les ouvertures. Disponible en bois sur multiplis de bouleau ou laqué sur MDF.

QUARANTA5, reine Formen und kompakte Abmessungen. Die perfekte Verbindung zwischen Türen, Oberplatten und Seitenteilen, mit 45°-Abkantung und keinerlei sichtbaren Stärken. Ein praktischer trapezförmiger Griff, der in die Front eingearbeitet ist, wird zu einem funktionalen und zugleich schmückenden Öffnungselement. Erhältlich aus Holz auf Birkenholz-Mehrschichtplatten oder lackiert auf MDF.

QUARANTA5, formas puras y volúmenes compactos. Uniones perfectas entre puertas, encimeras y costados, con corte a 45° y sin espesores vistos. Un cómodo tirador trapezoidal recortado en el frente se convierte en un elemento decorativo y funcional para la apertura. Disponible en madera sobre multicapa de abedul o lacado sobre MDF.

## CARATTERISTICHE QUARANTA5



Eucalipto affumicato con particolari laccati  
Zafferano opaco, lavabo monoblocco Q5 in  
Tecnoril, specchio Back e colonna girevole.

Eucalipto affumicato finish with Zafferano  
matt lacquered details, Tecnoril Q5 uniblock  
basin, Back mirror and rotating tall unit.

Eucalipto affumicato avec détails laquée  
Zafferano mat, vasque monobloc en Tecnoril  
Q5, miroir Back et colonne tournante.

Ausführung Eucalipto affumicato mit  
Details in Zafferano matt. Tecnorilplatte mit  
integriertem Waschbecken Q5, Spiegel Back  
und drehenden Hochschrank

Eucalipto affumicato con detalles lacados  
Zafferano mate, cuba monobloque de  
Tecnoril Q5, espejo Back y columna giratoria.

## COMPOSIZIONE Q-01 QUARANTA5

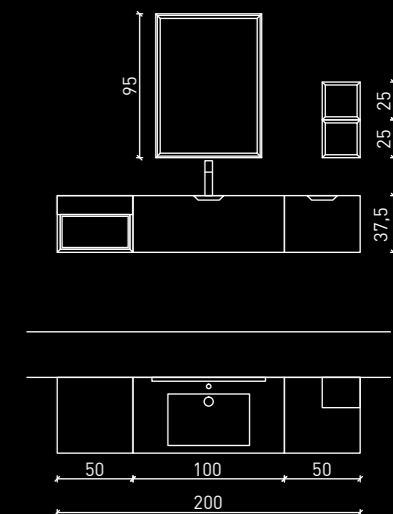













COMPOSIZIONE Q-01V

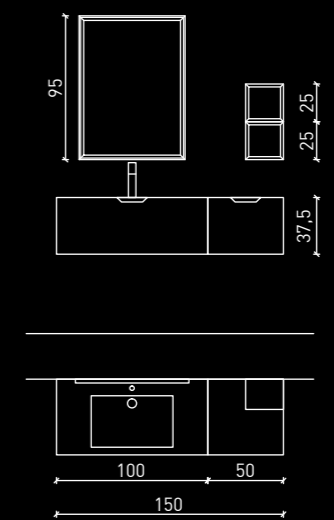





Rovere Nordico Naturale, top HPL Tobacco con vasca integrata termoformata, specchio Filo con lampada Metro. Colonna girevole.

Rovere Nordico Naturale finish, HPL Tobacco top with integrated washbasin, Filo mirror with Metro lamp. Rotating tall unit.

Rovere Nordico Naturale, plan de toilette en HPL Tobacco avec vasque intégrée, miroir Filo avec lampe Metro. Colonne tournante.

Ausführung Rovere Nordico Naturale. HPL platte mit integriertem Waschbecken, Spiegel Filo mit lampe Metro und drehenden Hochschrank.

Rovere Nordico Naturale, encimera de HPL Tobacco con cuba integrada, espejo Filo avec lámpara Metro. Columna giratoria.

## COMPOSIZIONE Q-02 QUARANTA5

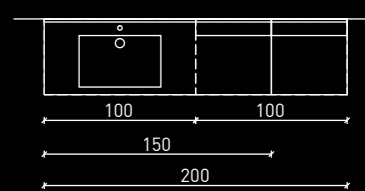
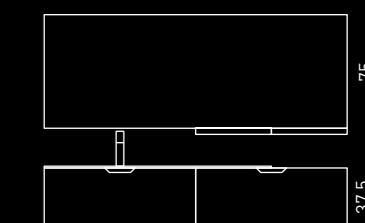















Laccato Bianco opaco con particolari laccati Titanio, top Tecnoril sp. 6 cm con vasca integrata, specchio Luna.

Bianco matt lacquered finish with Titanio lacquered details, th. 6 cm Tecnoril top with integrated washbasin, Luna mirror.

Laquée Bianco mat avec détails laquée Titanio, plan de toilette en Tecnoril ép. 6 cm avec vasque intégrée, miroir Luna.

Bianco matt lackiert mit Details lackiert Titanio. Tecnoril st.6 cm mit integriertem Waschbecken, Spiegel Mod. Luna.

Lacado Bianco mate con detalles lacados Titanio, encimera de Tecnoril esp. 6 cm con cuba integrada, espejo Luna.

## COMPOSIZIONE Q-03 QUARANTA5

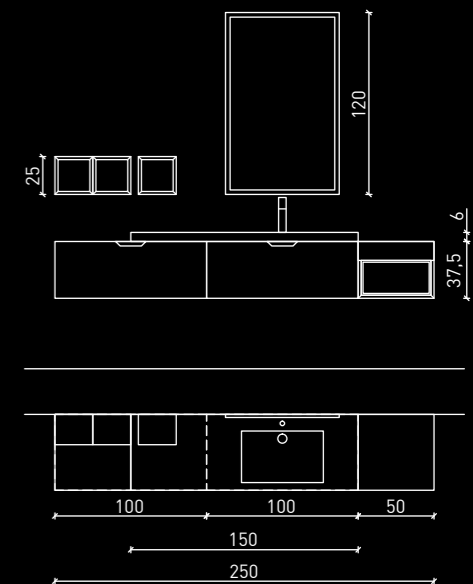

















**COMPOSIZIONE Q-03V**

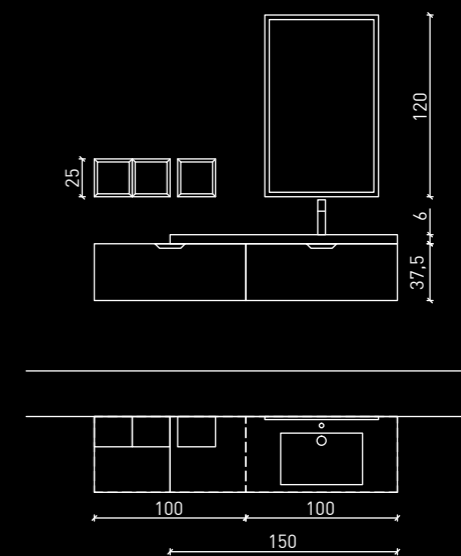





Noce Canaletto con vani a giorno laccati  
Titanio. Top Laminam Ossido Bruno sp. 6  
cm con vasca integrata, specchio Modular.

Noce Canaletto finish with Titanio lacquered  
open elements. Th. 6 cm Laminam Ossido  
Bruno top with integrated washbasin,  
Modular mirror.

Noce Canaletto, éléments ouvertes laquée  
Titanio. Plan de toilette en Laminam Ossido  
bruno ép. 6 cm avec vasque intégrée,  
miroir Modular.

Noce canaletto mit offene elementen in  
Titanio matt lackiert. Top Laminam ossido  
Bruno 6 cm mit integriertem Waschbecken,  
Spiegel Mod. Modular.

Noce canaletto con módulos abiertos lacados  
Titanio. Encimera esp. 6 cm de Tecnoril con  
cuba integrada, espejo Modular.

## COMPOSIZIONE Q-04 QUARANTA5

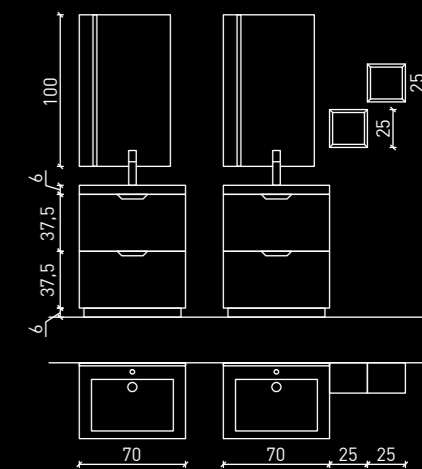

















Olmo con particolari laccato Bordeaux opaco, lavabi monoblocco Q5 in Tecnoril e specchi Modular.

Olmo finish with Bordeaux matt lacquered details, Q5 Tecnoril uniblock basins, Modular mirrors.

Olmo avec détails laquée Bordeaux mat, vasques monobloc en Tecnoril Q5, miroirs Modular.

Olmo mit Details bordeaux matt lackiert. Tecnorilplatte mit integriertem Waschbecken Q5 und Spiegel mod. Modular.

Olmo con detalles lacados Bordeaux mate, cuba monobloque de Tecnoril Q5, espejo Modular.

## COMPOSIZIONE Q-05 QUARANTA5

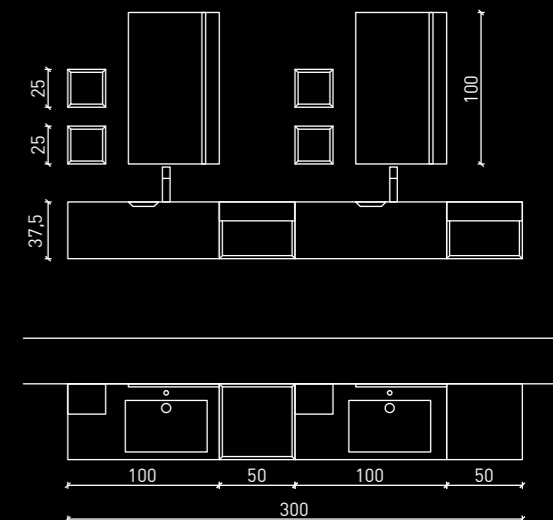

















**COMPOSIZIONE Q-05V**

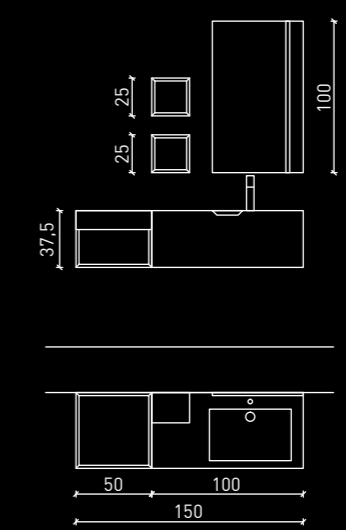





Laccato Ferro opaco con base a giorno  
impiallacciato Rovere Nordico naturale, top  
HPL Impero con lavabo Cover nero opaco.  
Specchio Gamma e lampade Tube in metallo  
Nero. Colonne con telaio Titanio e vetro fumé,  
illuminazione interna a Led.

## COMPOSIZIONE Q-06 QUARANTA5

Ferro matt lacquered finish with Rovere Nordico  
Naturale open base, HPL Impero top with black  
mat Cover basin. Gamma mirror and Tube lamps  
on metal black matt finished. Tall units with Titanio  
frame and fumé glass and internal led lighting.

Laquée Ferro mat avec élément bas ouvert en  
Rovere Nordico Naturale, plan de toilette en  
HPL Impero avec bassin Cover noir mat. Miroir  
Gamma et lampes Tube noir mat. Colonne  
avec cadre en aluminium Titanio et verre fumé  
et éclairage intérieur avec Led.

Ferro matt lackiert mit offenen elementen in  
Rovere Nordico Naturale furniert. Platte HPL  
Impero mit Auflagebecken Coverschwarz matt.  
Spiegel Gamma und Lampe Tube in schwarz  
metall. Hochschrank mit Titanio rahmen und  
glass fumé. Integrierte Led lampe.

Lacado Ferro Mate con mueble bajo abierto  
de Rovere Nordico Naturale, encimera de HPL  
Impero con cuba Cover negra mate. Espejo  
Gamma y Lámparas Tube negro mate.  
Columnas con marco de aluminio Titanio y  
cristal ahumado y iluminación interior.

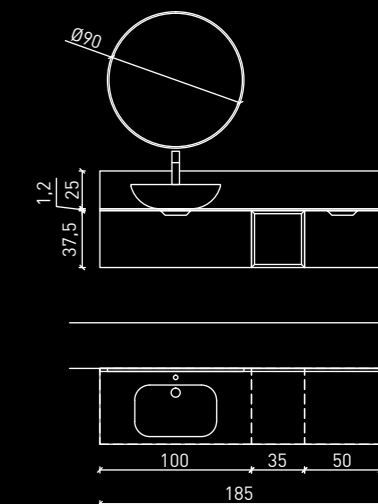











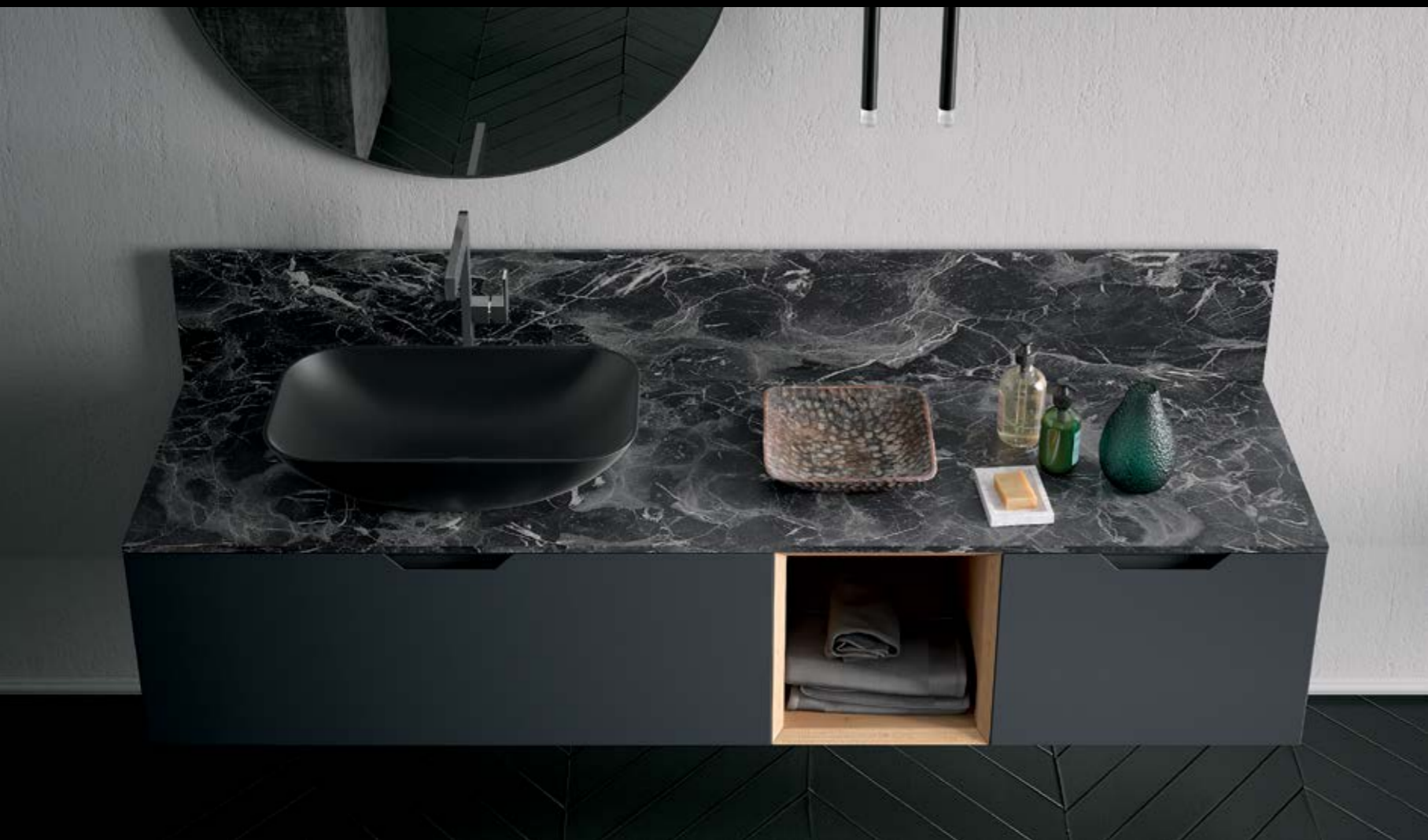



BASI LAVABO P. 50  
WASHBASIN UNITS D. 50  
ÉL. BAS SOUS-VASQUE P. 50  
WASHBECKEN-US T.50  
MUEBLES LAVABO P.50



BASI LAVABO MONOBLOCCO P. 50  
MONOBLOCK WASHBASIN UNITS D. 50  
ÉL. BAS SOUS-VASQUE MONO P. 50  
WASCHBECKEN-US T.50  
MUEBLES LAVABO MONOBLOQUE P. 50



BASI A GIORNO P. 50  
OPEN BASE UNITS D. 50  
ÉL. BAS OUVERTS P. 50  
OFFENE-US T.50  
MUEBLES ABIERTOS P.50

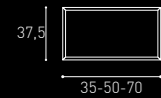

PENSILI A GIORNO P. 20 / 35  
OPEN WALL UNITS D. 20 / 35  
ÉL. HAUT OUVERTS P. 20 / 35  
OFFENE-HÄNGESCHRÄNKE T.25/35  
MÓDULOS ABIERTOS P.20/35

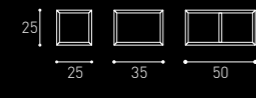

BASI P. 50  
BASE UNITS D. 50  
ÉL. BAS P. 50  
UNTERSCHRÄNKE T.50  
MUEBLES P. 50

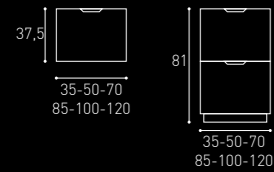

BASI SPECIALI P. 50  
SPECIAL BASE UNITS D. 50  
ÉL. BAS SPECIALS P. 50  
EXTRAELEMENTEN T.50  
MUEBLES ESPECIALES P.50

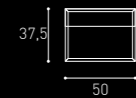

COLONNE P. 35  
TALL UNITS D. 35  
COLONNES P. 35  
HOCHSCHRÄNKE T.35  
COLUMNS P.35

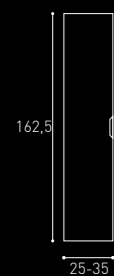

COLONNA GIREVOLE P. 35  
SWIVEL TALL UNIT D. 35  
COLONNE RENOUVELABLE P. 35  
DREHENDEN HOCHSCHRÄNKE T.35  
COLUMNA GIRATORIA P. 35

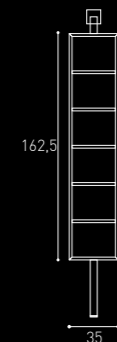

Impiallacciatura finiture LEGNI  
su multistrato di betulla, laccato opaco  
e lucido su MDF.

LEGNI finishes veneered wood on birch  
plywood, matt and gloss lacquered MDF.

LEGNI placage bois sur multiplis de  
bouleau, MDF laquée mat et brillant.

Merschichtigen Birkholz Furniert  
in Legni ausführung. Matt oder glanz  
lackierung auf MDF.

Chapeadas de maderas LEGNI  
su contrachapado de abedul, MDF  
lacado mate y brillo.

## SCHEDA TECNICA QUARANTA5



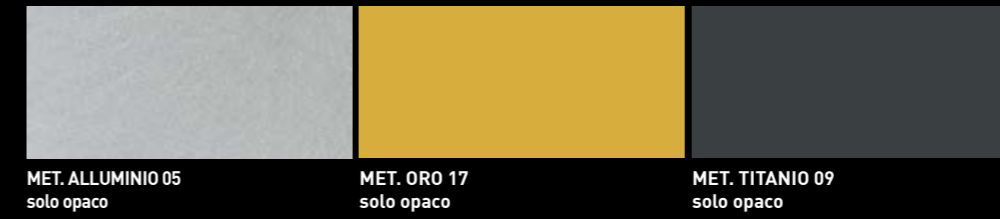

- ▲ LACCATI METALIZZATI
- ◀ LACCATO OPACO E LUCIDO
- ▼ LEGNI

# SCHEDA TECNICA QUARANTA5





CATALOGUE PLANNIG  
**Maurizio Poletto**

R. & S.  
**Archeda Srl**

DESIGN E A.D.  
**Dario Poles**

GRAPHIC DESIGN CATALOGO  
**Graphosds**

FOTOGRAFIA  
**Gabriotti Fotografi**

FOTOLITO E STAMPA  
**graficheitalprint.it**

**SETTEMBRE 2022**

Archeda, al fine di migliorare le caratteristiche tecniche e qualitative della sua produzione, si riserva di apportare, anche senza preavviso, tutte le modifiche che si rendessero necessarie.

To improve the technical and the qualitative characteristics of the production, Archeda reserves the right to make all the suitable modifications without previous notice.

A fin daméliorer les caractéristiques techniques et qualitatives de sa production, la société Archeda se réserve le droit d'apporter, même sans preavis, toutes les modifications qui seront jugées nécessaires.

Um technische und qualitative Merkmale der Produktion zu verbessern, behält sich Archeda vor, alle nötige Abänderungen, ohne Avisierungen, vorzunehmen.

Archeda, a fin de mejorar las características técnicas y cualitativas de su producción, se reserva el derecho de aportar, incluso sin previo aviso, todas las modificaciones necesarias.

