

SIDE

ESTETICA ESCLUSIVA DATA DALLE GEOMETRIE PURE DELLE MANIGLIE IN ALLUMINIO CHE POSSONO ESSERE APPLICATE AL CENTRO O ALL'ESTREMITÀ DEI FRONTALI. DISPONIBILE TRASVERSALMENTE IN TUTTE LE FINITURE DELLA GAMMA **ARCHEDA**. UN PROGETTO CARATTERIZZATO DA SEMPLICITÀ E RIGORE; UN INSIEME DI PROPOSTE FLESSIBILI, CAPACI DI SUGGERIRE FUNZIONALITÀ ED ESTETICA AL TEMPO STESSO.

SIDE

EXCLUSIVE AESTHETICS HAVE BEEN CREATED WITH SLICK GEOMETRIC ALUMINIUM HANDLES, WHICH CAN BE APPLIED IN THE MIDDLE OR AT THE END OF THE FRONTS. THIS VERSATILE FEATURE IS AVAILABLE IN ALL FINISHES IN THE **ARCHEDA** RANGE. THIS DESIGN PROJECT IS SIMPLE AND PRECISE, BRINGING TOGETHER A SELECTION OF FLEXIBLE PRODUCT IDEAS THAT LOOK GREAT BUT ARE ALSO PRACTICAL.

EXKLUSIVE ÄSTHETIK DURCH DIE REINE GEOMETRIE DER ALUMINIUMGRIFFE, DIE IN DER MITTE ODER AM ENDE DER FRONTEN ANGEBRACHT WERDEN KÖNNEN. ERHÄLTICH IN ALLEN AUSFÜHRUNGEN DER REIHE **ARCHEDA**. EINE KOLLEKTION, DIE SICH DURCH EINFACHHEIT UND STRENGE AUSZEICHNET; EINE REIHE FLEXIBLER LÖSUNGEN, DIE IN DER LAGE SIND, FUNKTIONALITÄT UND ÄSTHETIK ZU VERBINDEN.

ESTHÉTIQUE EXCLUSIVE DUE AUX GÉOMÉTRIES PURES DES POIGNÉES EN ALUMINIUM POUVANT ÊTRE APPLIQUÉES AU CENTRE OU À L'EXTRÉMITÉ DES FAÇADES. DISPONIBLE TRANSVERSALEMENT DANS TOUTES LES FINITIONS DE LA GAMME **ARCHEDA**. UN PROJET CARACTÉRISÉ PAR LA SIMPLICITÉ ET LA RIGUEUR ; UN ENSEMBLE DE PROPOSITIONS FLEXIBLES, EN MESURE DE SUGGÉRER À LA FOIS FONCTIONNALITÉ ET ESTHÉTIQUE.

UNA ESTÉTICA EXCLUSIVA FRUTO DE LAS FORMAS PURAS DE LOS TIRADORES DE ALUMINIO, QUE SE PUEDEN MONTAR EN EL CENTRO O EN EL EXTREMO DE LOS FRENTE. DISPONIBLE EN SENTIDO TRANSVERSAL EN TODOS LOS ACABADOS DE LA GAMA **ARCHEDA**. UN PROYECTO CARACTERIZADO POR SU SENCILLEZ Y RIGOR; UN CONJUNTO DE PROPUESTAS FLEXIBLES, CAPACES DE TRANSMITIR FUNCIONALIDAD Y ESTÉTICA AL MISMO TIEMPO.

MANIGLIE

Handles / Poignées
Griffe / Tiradores

MANIGLIA INTERA

Full handle
Poignée entière
Ganzer Griff
Tirador entero

MANIGLIA DESTRA

Right handle
Poignée droite
Rechter Griff
Tirador derecho

COMPOSIZIONI

Compositions / Compositions
Kompositionen / Composiciones

FRONTALE SINGOLO MANIGLIA LATERALE

Single front - Side handle
Simple façade - Poignée latérale
Einzelne Front - Seitengriff
Solo frente - Tirador lateral

FRONTALE SINGOLO MANIGLIA INTERA

Single front - Full handle
Simple façade - Poignée entière
Einzelne Front - Ganzer Griff
Solo frente - Tirador entero

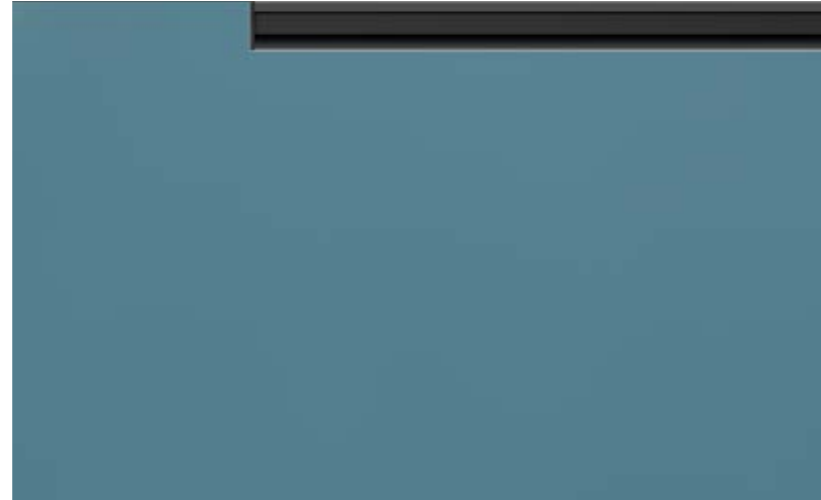
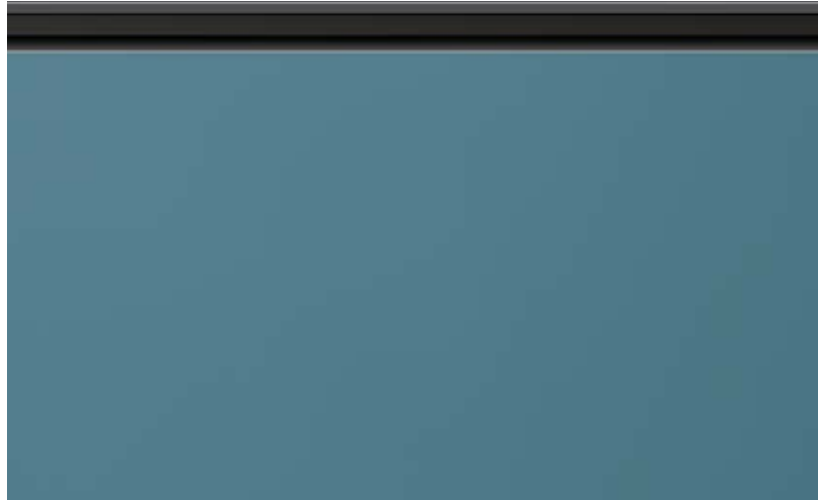

TITANIO



ALLUMINIO
SATINATO



MANIGLIE FINITURE

Handles finishes
Finitions des poignées
Griffe Oberflächen
Acabados

MANIGLIA SINISTRA

Left handle
Poignée gauche
Linker Griff
Tirador izquierdo

3 FRONTALI MANIGLIE LATERALI + INTERA

3 fronts - side+full handles
3 façades - poignées latérales+entière
3 Fronten - Seitengriffe+Ganzergriff
3 frentes - Tiradores laterales+entero

2 FRONTALI MANIGLIE LATERALI

2 fronts - side handles
2 façades - poignées latérales
2 Fronten - Seitengriffe
2 frentes - Tiradores laterales

COMPOSIZIONE 01

Hpl Tobacco 440 con maniglia Titanio e base a giorno laccata Fard opaco. Top in HPL Tobacco 440 con lavabo Lake in vetro fumé. Specchio Saturn con lampada Compasso.

Hpl Tobacco 440 with Titanio handle and Fard matt lacquered open element. Hpl Tobacco 440 top with fumé glass basin Lake. Saturn mirror with Compasso Lamp.

Hpl Tobacco 440 avec poignée Titanio et élément ouvert Fard mat. Plan de toilette en Hpl Tobacco 440 avec vasque en verre fumé Lake. Miroir Saturn avec lampe Compasso.

Hpl Tobacco 440 mit Griffe Titanio und offen Unterschrank Fard matt lackiert. Waschtischplatte Hpl Tobacco 440 mit Becken Lake aus Dunkelgrauglas. Spiegel Saturn mit Lampe Compasso.

Hpl Tobacco 440 con tirador Titanio y módulo abierto Fard mate. Encimera de Hpl Tobacco 440 con cuba Lake de vidrio ahumado. Espejo Saturn con lámpara Compasso.

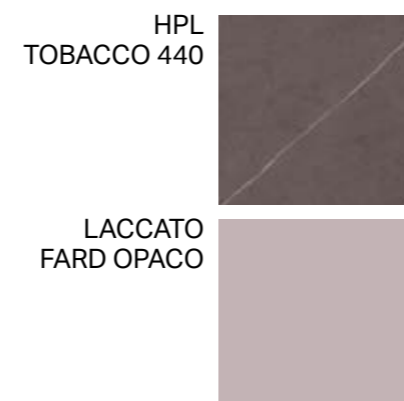
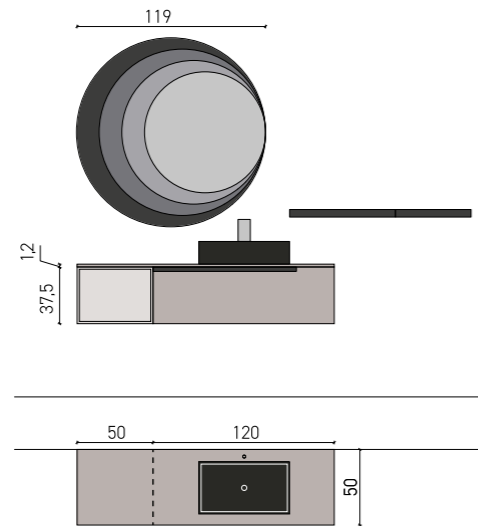



**La linearità unita
all'armonia**

Linear harmony
La linéarité unie à l'harmonie
Linearität mit Harmonie vereint
La linealidad unida a la armonía



**Lavabo Lake
in vetro grigio fumè**

Lake washbasin in Fumé glass
Lavabo Lake en verre Fumé
Waschbecken Lake aus Dunkelgrauglas
Lavabo Lake de cristal gris fumé



**Specchio Saturn:
sfumature che donano emozioni**

Saturn mirror: shades guaranteed to stimulate the senses

Miroir Saturn : des nuances qui donnent des émotions

Spiegel Saturn: Nuancen, die Emotionen wecken

Espejo Saturn: matices que aportan emociones



COMPOSIZIONE 02

**Bimelaminico Minato e laccato
Petrolio opaco con maniglie Titanio.
Top Corian con vasca integrata
CN. Specchi Jupiter e Sputnik con
lampada Compasso.**

Minato Bimelaminated and Petrolio
matt with Titanio handles. Corian top
with CN integrated basin. Jupiter and
Sputnik mirrors with Compasso.

Bi-mélatiné Minato et Petrolio mat et
poignée Titanio. Pd.T en Corian avec
vasque intégrée CN. Miroirs Jupiter et
Sputnik avec lampe Compasso.

Bimelamin Minato und Petrolio
lackiert matt mit Griffen Titanio.
Waschtischplatte Corian mit
integriertem Becken CN.
Jupiter und Sputnik Spiegeln mit
Lampe Compasso.

Bi-melamina Minato y lacado Petrolio
mate con tiradores Titanio. Encimera
Corian con cuba integrada CN.
Espejos Jupiter y Sputnik con
lámpara Compasso.

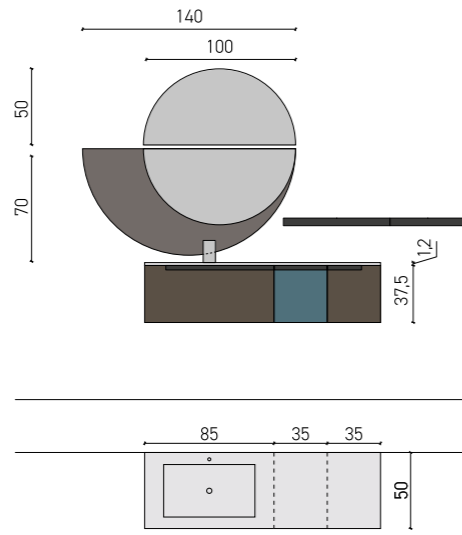

BIMELAMINICO
MINATO

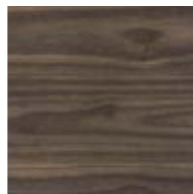

LACCATO
PETROLIO OPACO



CORIAN







**Movimenti in libertà:
la lampada Compasso**

Move freely with the Compasso light
Mouvements en liberté : la lampe Compasso
Bewegungen voller Freiheit: die Lampe Compasso
Libertad de movimiento: la lámpara Compasso

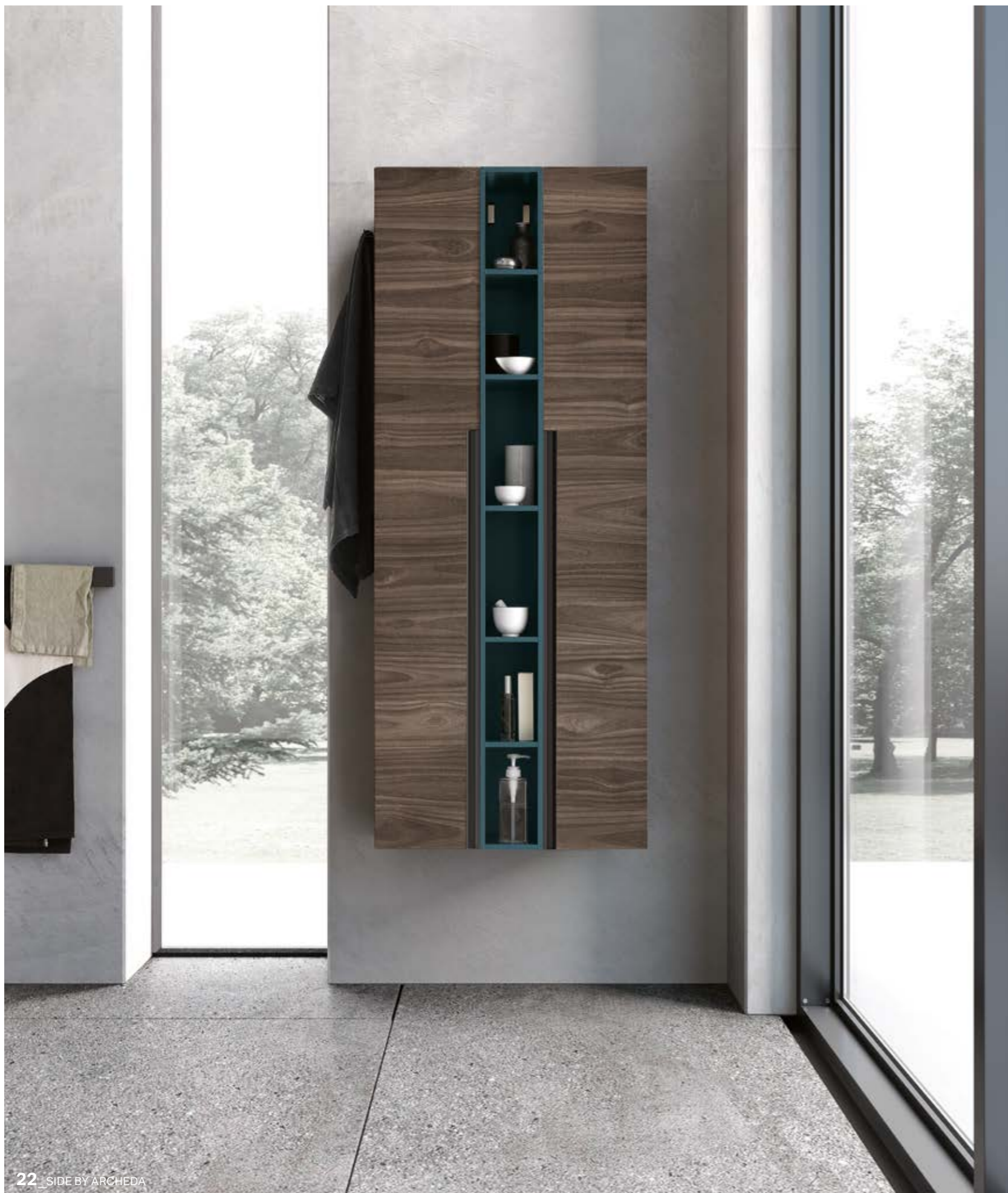

**Le colonne:
contenere in piena vista**

Storage space in full view with these tall units
Les colonnes : ranger en pleine vue
Unsere Hochschränke: Aufbewahren mit Einblicken
Las columnas: almacenamiento a plena vista





COMPOSIZIONE 03

Basi finitura bmelaminico Ares Beton e Ares Calce con maniglie alluminio satinato e top H. 6 cm in gres Pietra Grey con vasca integrata GF. Specchi Sputnik con illuminazione a led perimetrale.

Ares Beton and Ares Calce bmelaminated base units with aluminium matt handles. Th.6 cm Pietra Grey gres tops with GF integrated basins. Sputnik mirrors with perimetral led lighting.

Éléments bas en bi-méla miné Ares Beton et Ares Calce avec poignée aluminium et Pd.T. en Gres Pietra Grey avec vasque intégrée GF. Miroirs Sputnik avec éclairage périmétrique.

Unterschränke aus Bimelamin Ares Beton und Ares Calce mit Griffe Aluminium Satiniert und Waschtischplatten Gres Pietra Grey St.6 cm mit integriertem Becken GF. Spiegeln Sputnik mit perimetralen-LED.

Muebles de suelo en bi-melamina Ares Beton y Ares Calce con tiradores aluminio y encimera esp. 6 cm de gres Pietra Grey con cuba integrada GF. Espejos Sputnik con iluminación LED perimetral.

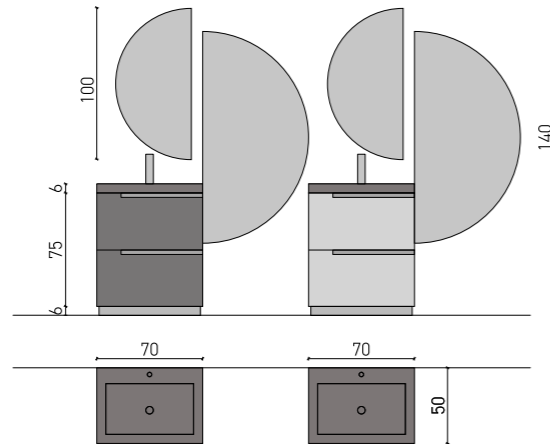

BIMELAMICO
ARES BETON



BIMELAMICO
ARES CALCE



GRES
PIETRA GREY



**Piccoli volumi
per grandi emozioni**

Small shapes for big ideas
De petits volumes pour de grandes émotions
Kleine Volumen für große Emotionen
Pequeños volúmenes para grandes emociones





Scorci sui dettagli più accattivanti

Captivating details
Aperçus sur les détails les plus captivants
Entdecken Sie die fesselndsten Details
Un vistazo a los detalles más interesantes



**Accessori INSIDE: la linearità
che contiene con classe ed eleganza**

INSIDE accessories: linear storage space offering class and elegance
Accessoires INSIDE : la linéarité qui contient avec classe et élégance
INSIDE-Accessoires: Linearität mit Klasse und Eleganz
Accesorios INSIDE: la linealidad que almacena con clase y elegancia





COMPOSIZIONE 04

Bimelaminico Rovere Spaccato con maniglie Titanio e top in gres Ossido Bruno con vasca integrata GK. Specchi esagonali Ride con profilo nero e illuminazione perimetrale a led.

Rovere Spaccato Bimelaminated with Titanio handles. Ossido Bruno gres top with GK integrated basin. Ride hexagonal mirrors with black aluminum profile and perimetral led lighting.

Bi-mélatiné Rovere Spaccato avec poignée Titanio et Pd.T en gres Ossido Bruno avec vasque intégrée GK. Miroirs hexagonaux Ride avec profils noirs et éclairage périmétrique.

Bimelamin Rovere Spaccato mit Griffen Titanio und Waschtischplatte Gres Ossido Bruno St. 6 cm mit integriertem Becken GK. Sechseckigen Ride Spiegel mit schwarzem Profil und perimetralen-Led.

Bi-melamina Rovere Spaccato con tiradores Titanio y encimera de gres Ossido Bruno con cuba integrada GK. Espejos hexagonales Ride con perfil negro y iluminación LED perimetral.

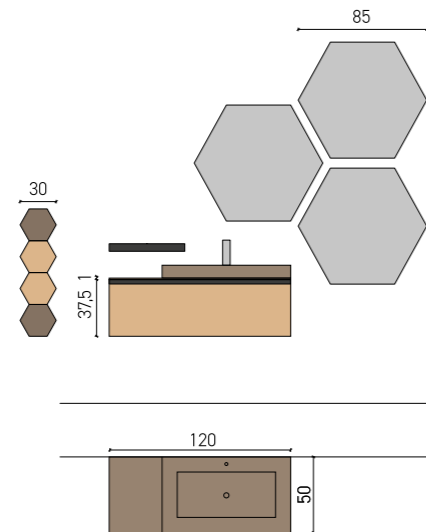

BIMELAMINICO
ROVERE SPACCATO



LACCATO
LIQUIRIZIA OPACO



GRES
OSSIDO BRUNO

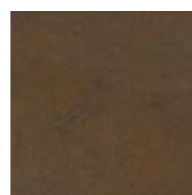



**Complementi che arredano
con stile ed eleganza**

Furnishings to decorate your space in style and elegance
Des compléments qui décorent avec style et élégance
Einrichtungsgegenstände, die mit Stil und Eleganz einrichten
Complementos que amueblan con estilo y elegancia



**Attenzione e cura
per i dettagli**

Attention to detail
Attention et soin des détails
Aufmerksamkeit und Liebe zum Detail
Atención y cuidado en los detalles



**Tonalità calde ed avvolgenti:
rovere spaccato e liquirizia opaco**

Warm, inviting shades: Rovere Spaccato and matt Liquirizia
Tonalités chaudes et enveloppantes : Rovere Spaccato et Liquirizia Mat
Warme und einhüllende Farbtöne: Rovere Spaccato und Liquirizia Matt
Tonos cálidos y envolventes: Rovere Spaccato y Liquirizia Mate





COMPOSIZIONE 05

Anice opaco con maniglie Titanio e top Geacryl color Matt Anice h.6 cm con vasca integrata G. Specchio Ride con lampada Pens. Elementi a giorno esagonali in metallo Titanio con retro laccato Anice opaco.

Anice matt lacquered with Titanio handles and th. 6 cm Geacryl Color matt top in Anice finish with G integrated basin. Ride mirror with Pens lamp. Hexagonal Titanio painted metal open elements with Anice matt lacquered backs.

Anice mat avec poignée Titanio et P.d.T en Geacryl Color Matt Anice ép. 6 cm avec vasque intégrée G. Miroir Ride avec lampe Pens. Éléments ouverts hexagonaux en métal titanio et Anice mat.

Anice matt lackiert mit Griffen Titanio und Waschtischplatte Geacryl Color Matt Anice St. 6 cm mit integriertem Becken G. Spiegel Ride mit Lampe Pens. Sechseckigen offene Metallelementen Titanio mit Rückwand Anice matt lackiert.

Anice mate con tiradores Titanio y encimera de Geacryl Color Matt Anice esp. 6 cm con cuba integrada G. Espejo Ride con lámpara Pens. Módulos abiertos hexagonales de metal Titanio con panel trasero lacado Anice mate.

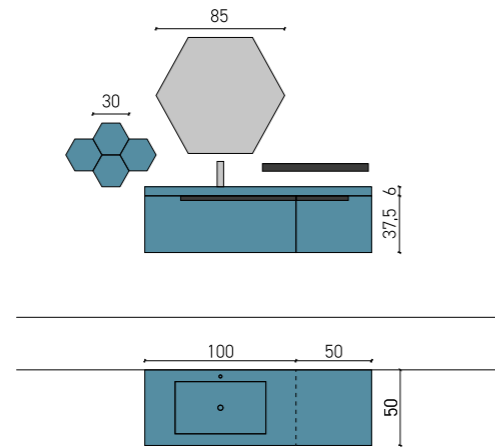

LACCATO
ANICE OPACO



GEACRYL
COLOR MATT ANICE



**Giochi di forme
e di colori**

Play with shapes and colours
Jeux de formes et de coloris
Form- und Farbspiele
Juegos de formas y colores





Top in Geacryl Color Matt in tutte le tonalità opache Archeda

Geacryl Color Matt top in all Archeda matt shades
Plan de toilette en Geacryl Color Matt dans toutes les tonalités mates Archeda
Geacryl Color Matt-Platte in verschiedenen matten Farbtönen der Reihe Archeda
Encimera de Geacryl Color Matt en todos los tonos mate de Archeda







COMPOSIZIONE 06

Bimelaminico Shibuya con maniglie Titanio. Top in Fenix Nero 720 con vasca integrata HG. Specchi Line con lampada Compasso.

Shibuya bimelaminated with Titanio handles. Fenix Nero 720 top with HG integrated basin. Line mirrors with Compasso lamp.

Bi-mélatiné Shibuya avec poignée Titanio. Pd.T en Fenix Nero 720 avec vasque intégrée HG. Miroirs Line avec lampe Compasso.

Bimelamin Shibuya mit Griffen Titanio. Waschtischplatte Fenix Nero 720 mit integriertem Becken HG. Spiegel Line mit Lampe Compasso.

Bi-melamina Shibuya con tiradores Titanio. Encimera de Fenix Nero 720 con cuba integrada HG. Espejos Line con lámpara Compasso.

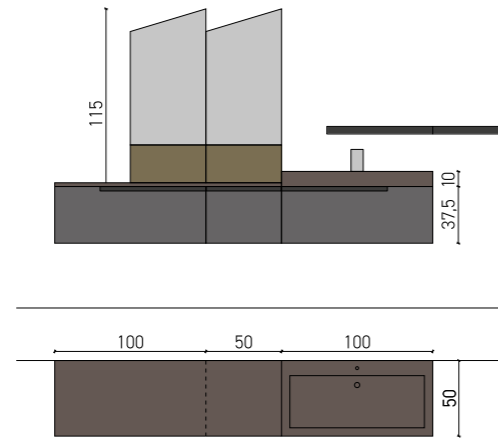

BIMELAMINICO
SHIBUYA



FENIX
NERO 720





**Proposte sempre versatili
e dallo stile unico**

Versatile products offering unique style
Des propositions toujours versatiles et au style unique
Immer vielseitige und einzigartige Stilvorschläge
Propuestas siempre versátiles y de estilo único

**Lampada Compasso:
scegli la tua angolazione preferita**

Compasso light: choose your favourite angle
Lampe Compasso : choisissez votre angle préféré
Lampe Compasso: Wählen Sie Ihren Lieblingswinkel
Lámpara Compasso: elige tu ángulo favorito





**Tutto a posto:
i cassettoni attrezzati con Inside**

Everything has its place: spacious, accessorised drawers with Inside
Tout est à sa place : les grands tiroirs équipés avec Inside
Alles an seinem Platz: Schubladen ausgestattet mit Inside
Todo en su sitio: las gavetas equipadas con Inside



**Archeda:
arredare con una marcia in più**

Archeda: interior design with an edge
Archeda : meubler à la vitesse supérieure
Archeda: Einrichten auf der Überholspur
Archeda: amueblar subiendo de marcha



COMPOSIZIONE 07

Hpl Antique con maniglie Titanio;
piano in vetro acidato Bosco con
vasca integrata VF. Specchi Bee in
metallo Titanio con lampade Pens.

Hpl Antique with Titanio handles;
Bosco acid-etched glass top with
VF integrated basins. Titanio metal Bee
mirrors with Pens lamps.

Hpl Antique avec poignée Titanio. Pd.T
en verre dépoli Bosco avec vasque
intégrée VF. Miroirs Bee en métal
Titanio avec lampes Pens.

Hpl Antique mit Griffen Titanio;
Waschtischplatte Glas geätzt Bosco mit
VF integriertem Becken. Spiegeln Bee
aus Metall Titanio mit Lampen Pens.

Hpl Antique con tiradores Titanio;
encimera de cristal al ácido Bosco
con cuba integrada VF. Espejos Bee
de metal Titanio con lámparas Pens.

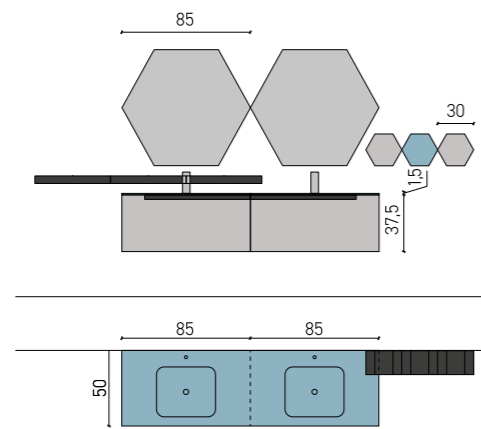

HPL
ANTIQUE



LACCATO
BOSCO OPACO



VETRO ACIDATO
BOSCO





**Materiali diversi
per uno stile unico**

Different materials for a unique style
Différents matériaux pour un style unique
Verschiedene Materialien für einen einzigartigen Stil
Diferentes materiales para un estilo único

**Vetro acidato:
scegli la tua tonalità**

Acid-etched glass: choose your shade
Verre dépoli : choisissez votre tonalité
Geätztes Glas: Wählen Sie Ihren Farbton
Cristal al ácido: elige tu tono



**Elementi a giorno Esagono,
che finitura dello schienale scegli?**

Esagono open elements: choose your back finish
Éléments ouverts Esagono : quelle finition choisissez-vous pour le fond ?
Esagono Offenelemente: Welches Finish wählen Sie für die Rückwand?
Elementos abiertos Esagono: ¿qué acabado eliges para la trasera?





COMPOSIZIONE 08

Blu Moby opaco con maniglie alluminio satinato e piano in vetro acidato Cipria con vasca integrata VG. Elementi a giorno in metallo bianco con retro laccato Fard e Finestra opaco, specchio Luna.

Blu Moby matt with aluminim handles and Cipria acid-etched glass top with VG integrated basin. White metal open elements with Fard matt end Finestra matt lacquered backs, Luna mirror.

Blu Moby matt avec poignées aluminium et Pd.T en verre dépoli Cipria avec vasque intégrée VG. Éléments ouverts en métal blanc et panneau arrière lacquée Fard et Finestra mat, miroir Luna.

Blu Moby matt lackiert mit Griffen Aluminium Satiniert un Waschtischplatte Glas geätzt Cipria mit VG integriertem Becken. Offene Metallelementen Titanio mit Rückwande Fard un Finestra lackiert. Spiegel Luna.

Lacado Blu Moby mate con tiradores aluminio y encimera cristal al ácido Cipria con cuba integrada VG. Módulos abiertos de metal blanco con panel trasero lacado Fard mate y Finestra mate, espejo Luna.

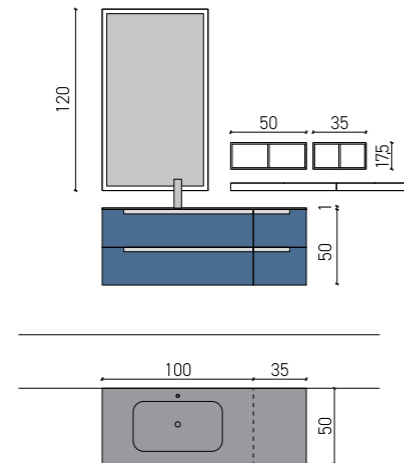

LACCATO
BLU MOBY OPACO



VETRO ACIDATO
CIPRIA

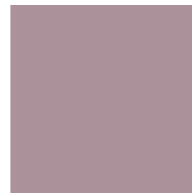

LACCATO
FARD OPACO



LACCATO
FINESTRA OPACO



LACCATO
CIPRIA OPACO



**Modularità creativa
per arredare con Archeda**

Creative modular units to design your interiors with Archeda
Modularité créative pour meubler avec Archeda
Archeda bietet Ihnen kreative Modularität bei der Ausstattung
Modularidad creativa para amueblar con Archeda



**Accessori Strike e cassetti attrezzati Inside:
scegli la tua combinazione**

Strike accessories and accessorised Inside drawers: choose your combination
Accessoires Strike et tiroirs équipés Inside : choisissez votre combinaison
Zubehör Strike und ausgestattete Schubladen Inside: Wählen Sie Ihre Kombination
Accesorios Strike y cajones equipados Inside: elige tu combinación







COMPOSIZIONE 09

Bianco opaco con maniglia Titanio e base a giorno Titanio opaco. Top in gres Striato opaco con lavabo Regolo in Tecnoril. Specchi Sputnik con led perimetrali e lampade a sospensione Tube nere.

White matt with Titanio handles and Titanio matt lacquered open element. Striato gres top with Tecnoril Regolo basin. Sputnik mirrors with perimetral led lighting and Tube black hanging lamps.

Bianco mat avec poignée Titanio et éléments bas ouvert lacquée Titanio mat. P.d.T en gres Striato opaco avec vasque Regolo en Tecnoril. Miroirs Sputnik avec éclairage périmétrique et lampe Tube noir.

Bianco matt lackiert mit Griffe Titanio und offen Unterschrank Titanio matt lackiert. Waschtischplatte Gres Striato opaco mit Becken Tecnoril Regolo. Spiegel Sputnik mit perimetralen-LED und schwarzen Lampen Tube.

Bianco mate con tiradores Titanio y módulo abierto Titanio mate. Encimera de gres Striato opaco con cuba Regolo de Tecnoril. Espejos Sputnik con iluminación LED perimetral y lámparas Tube negras.

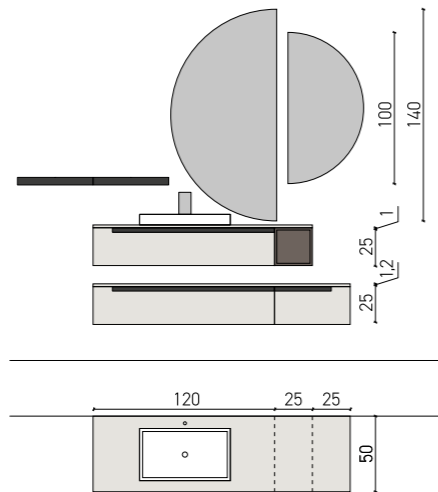

GRES
STRIATO OPACO



LACCATO
BIANCO OPACO



LACCATO
TITANIO OPACO

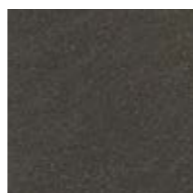

**Contrasti cromatici
per i piccoli dettagli**

Small details with colour contrasts
Contrastes chromatiques pour les petits détails
Farbkontraste für kleine Details
Contrastes cromáticos para los pequeños detalles





**Armonie di colori
in un contrasto di texture**

Harmonious colours and contrasting textures
Harmonie de coloris dans un contraste de texture
Harmonie der Farben in Kontrast zu den Strukturen
Armonía de colores en un contraste de texturas



**Scegli il tuo stile
in completa libertà**

Choose your own style in absolute freedom
Choisissez votre style en toute liberté
Wählen Sie Ihren Stil völlig frei
Elige tu estilo con total libertad





Specchi

Mirrors
Miroirs
Spiegeln
Espejos

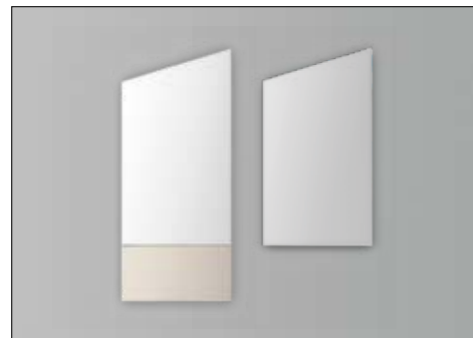

SKY + LINE

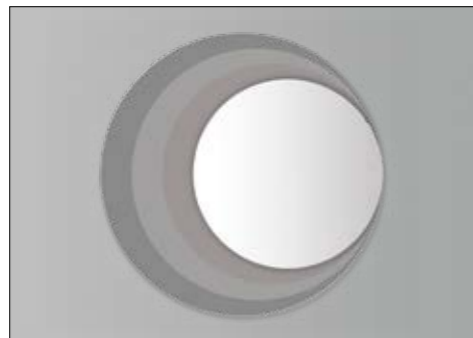

SATURN

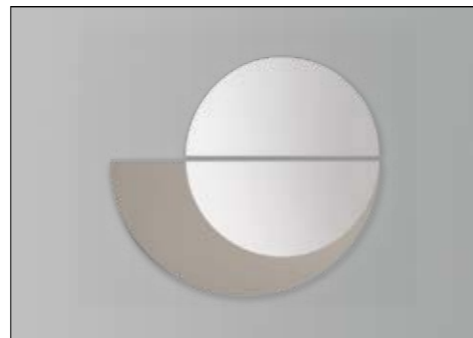

JUPITER + SPUTNIK

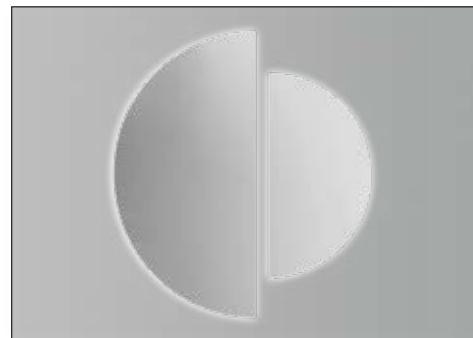

SPUTNIK

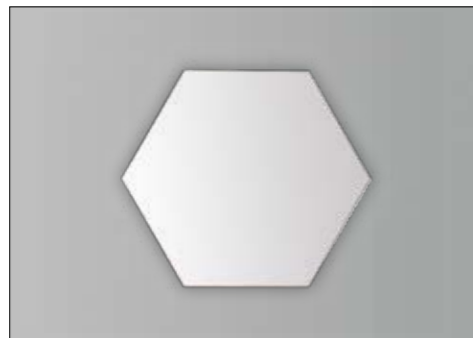

RIDE



BEE

**Inside:
accessori per cassetti**

Inside: accessories for drawers
Inside: accessoires pour tiroirs
Inside: Accessoires für Schubladen
Inside: accesorios para cajones Inside



L. 50 P. 50



L. 60 P. 50



L. 70 P. 50



L. 85 P. 50



L. 95 P. 50



L. 100 P. 50



L. 105 P. 50



L. 120 P. 50

Nuove finiture

New finishes
Nouvelles finitions
Neue Oberflächen
Nuevos acabados



Top Geacryl Color Matt

Geacryl Color Matt top
Pd.T Geacryl Color Matt
Waschtischplatte Geacryl Color Matt
Encimera de Geacryl Color Matt



(no bianco, nero, oro,
alluminio e titanio)



Fenix

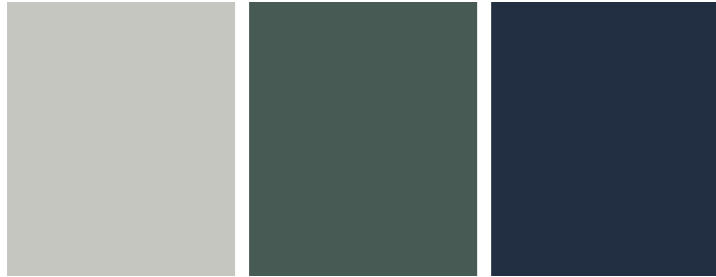

GRIGIO
EFESO 725

VERDE COMODORO
750

BLU
FES 754

Hpl

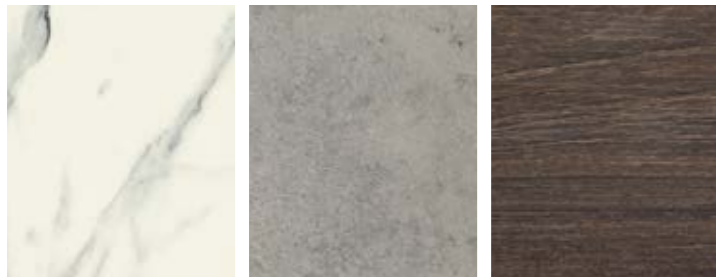

STATUARIO S. T. 439

CEMENTO 143

OLMO SCURO 303

Bimelaminico syncro

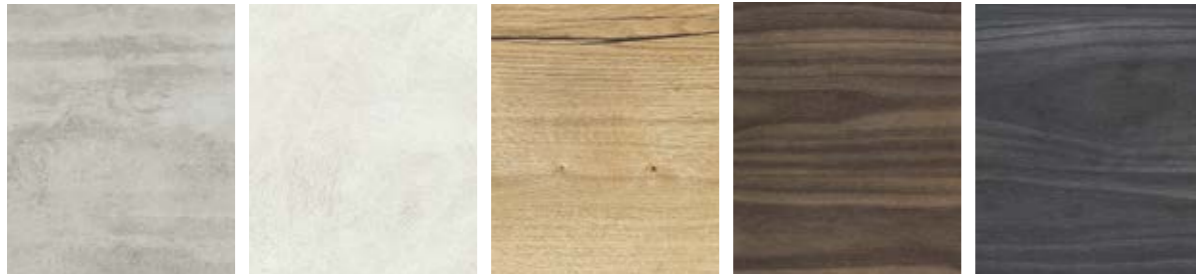

ARES BETON

ARES CALCE

ROVERE SPACCATO

MINATO

SHIBUYA

Top in vetro acidato

Acid-etched glass top
Plan de toilette en verre dépoli
Geätzte Glasplatte
Encimera de cristal al ácido



(no nero)



Finiture

Finishes
Finitions
Oberflächen
Acabados

Laccato opaco/lucido

Matt/gloss lacquered / Lacquée mat et brillant
Matt oder glänzend lackiert / Lacado mate y brillo



BIANCO 01 NUVOLA 58 CENERE 06 KAKI 07 GRAFITE 02 FERRO 03 NERO 04



VANIGLIA 59 JUTA 60 CANAPA 61 LIQUIRIZIA 62 FANGO 63 TERRA 14 CACAO 64



PAPIRO 57 AVENA 56 FIENO 55 GIADA 38 BOSCO 37 PETROLIO 72 NAFTA 75



TURCHESE 74 MENTA 73 PAVONE 71 NEBBIA 39 POLVERE 46 ANICE 49 AVIO 44



BLU MOBY 47 OLTREMARE 48 LINO 49 FINESTRA 08 FARD 54 CIPRIA 53 CARMINIO 29



BORDEAUX 24 ROSSO INDIA 26 AMBRA 16 ZAFFERANO 15 RAL + NCS

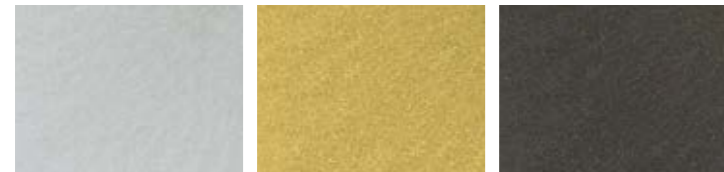

MET. ALLUMINIO 05* MET. ORO 17* MET. TITANIO 09*

*Solo opaco
Matt only / Seulement mat
Nur matt / Solo mate

Finiture

Finishes
Finitions
Oberflächen
Acabados

Laccato metal

Metal lacquered / Lacqué Metal
Metal lackiert / Lacado Metal



OTTONE ANTICO CORTEN ACCIAIO

Bimelaminico skin

Bimelaminated Skin / Bi-mé laminé Skin
Bimelamin Skin / Bi-melamina Skin



SKIN BIANCO SKIN GRIGIO SKIN JEREZ

Bimelaminico syncro

Bimelaminated Syncro / Bi-mé laminé Syncro
Bimelamin Syncro / Bi-melamina Syncro



ARES BETON ARES CALCE ROVERE SPACCATO MINATO SHIBUYA



OLMO COCCO NODATO LONDRA NODATO SAVANA NODATO CANYON

Finiture

Finishes
Finitions
Oberflächen
Acabados

Legni

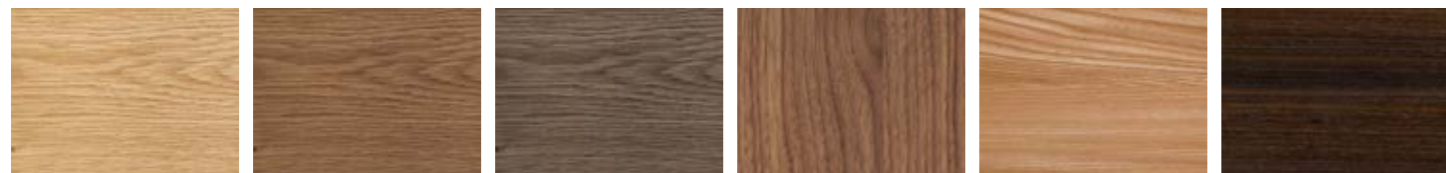

ROVERE NORDICO
NATURALE

ROVERE NORDICO
CIOCCOLATO

ROVERE NORDICO
CAFFÈ

NOCE CANALETTO

OLMO

EUCALIPTO AFFUMI-
CATO

Rovere fiammato decapé

Decapé Fiammato Oak / Chêne Fiammato Decapé
Decapé Fiammato Eiche / Roble Fiammato Decapé

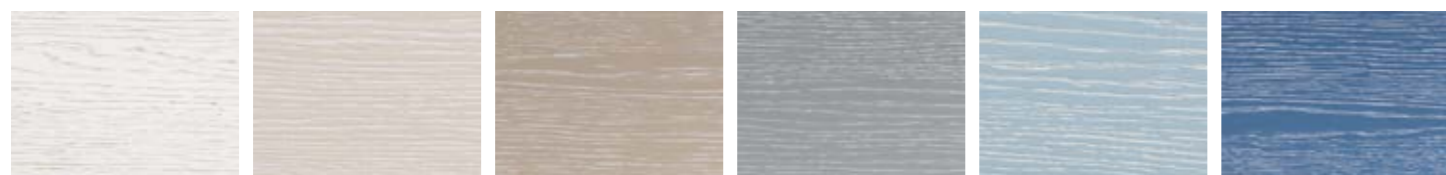

BIANCO PORO SCURO

JUTA PORO BIANCO

CANAPA PORO
BIANCO

FINESTRA PORO
BIANCO

POLVERE PORO
BIANCO

AVIO PORO BIANCO

Rovere fiammato tinto

Fiammato Oak / Chêne Fiammato Teinté
Fiammato Eiche / Roble Fiammato

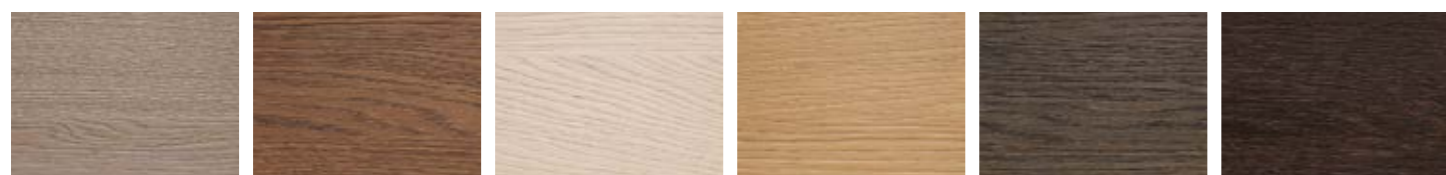

AGATA

CASTAGNA

CORDA

GRANO

QUARZO

TARTUFO

Rovere fiammato laccato poro aperto

Open pore lacquered Fiammato Oak / Chêne Fiammato lacqué pore ouvert
Offen porig lackiert Fiammato Eiche / Roble Fiammato lacado poro abierto



BIANCO



CAMPIONARIO ARCHEDA

Finiture

Finishes
Finitions
Oberflächen
Acabados

Hpl unicolor



STATUARIO S. T. 439

CEMENTO 143

OLMO SCURO 303

OLMO BIONDO 134

ROVERE MONET 423

ROVERE TEXAS 306

ROVERE VERSAILLES 418

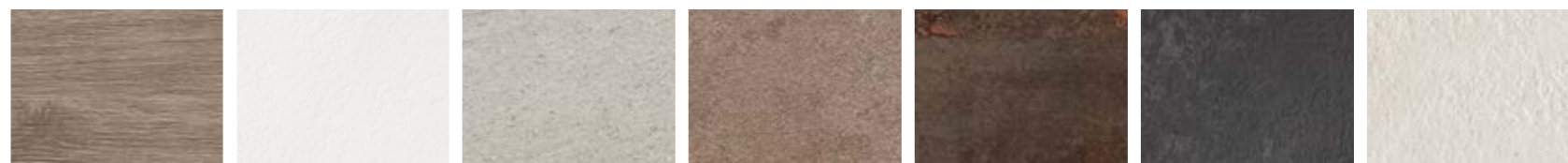

ROVERE CASTORO
301

SASSO 139

BASALTO 403

PORFIDO 119

OSSIDO 146

ARDESIA 145

MALTA BIANCA 430



MALTA GRIGIA 431

MALTA CANAPA 432

ANTIQUE

MAILAND 441

BOTTICINO 410

CUMA DARK 428

CALYPSO 435



TOBACCO 440

IMPERO 438

Fenix



GRIGIO
EFESO 725

VERDE COMODORO
750

BLU
FES 754

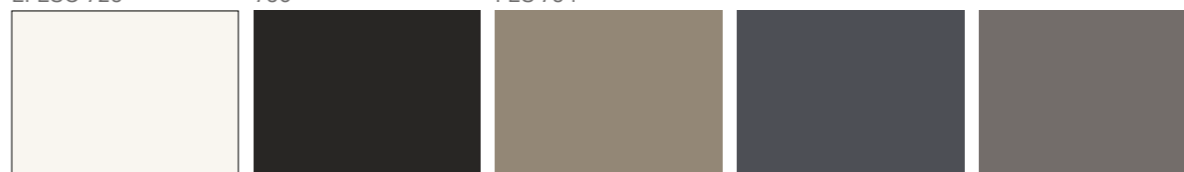

BIANCO 32

NERO 720

BIBER 717

BROMO 724

GRIGIO 718

CATALOGUE PLANNIG
Maurizio Poletto

DESIGN E A.D.
Dario Poles

GRAPHIC DESIGN CATALOGO
Graphosds

FOTOGRAFIA
Gabriotti Fotografi

FOTOLITO E STAMPA
graficheitalprint.it

NOVEMBRE 2020

Archeda, al fine di migliorare le caratteristiche tecniche e qualitative della sua produzione, si riserva di apportare, anche senza preavviso, tutte le modifiche che si rendessero necessarie.

To improve the technical and the qualitative characteristics of the production, Archeda reserves the right to make all the suitable modifications without previous notice.

A fin daméliorer les caractéristiques techniques et qualitatives de sa production, la société Archeda se réserve le droit d'apporter, même sans preavis, toutes les modifications qui seront jugées nécessaires.

Um technische und qualitative Merkmale der Produktion zu verbessern, behält sich Archeda vor, alle nötige Abänderungen, ohne Avisierungen, vorzunehmen.

Archeda, a fin de mejorar las características técnicas y cualitativas de su producción, se reserva el derecho de aportar, incluso sin previo aviso, todas las modificaciones necesarias.



ARCHEDA s.r.l. via A. Malignani, 7 33080 Porcia (Pn) www.archeda.eu