

TULLE

SISTEMA GOLA

TULLE

SISTEMA GOLA



TULLE

TULLE, UN MOBILE CON GOLA STRUTTURALE PIATTA E FRONTALI PIANI CON BORDO INCLINATO, ESTREMAMENTE AGEVOLE E FUNZIONALE. IL FIANCO DI FINITURA SP. 1,2 CM FINISCE E RIDEFINISCE IL PROFILO DELLA COMPOSIZIONE TULLE PERMETTENDO MOLTEPLICI VARIANTI. LE FORME E I VOLUMI VENGONO REINTERPRETATI, OFFRENDO SOLUZIONI COMPOSITIVE E FUNZIONALI PER OGNI ESIGENZA

TULLE, A FURNITURE WITH A FLAT STRUCTURAL GROOVE AND SMOOTH FRONT PANELS WITH AN INCLINED EDGE, EXTREMELY EASY AND FUNCTIONAL. THE 1.2 CM THICKNESS FINISHING SIDE FINISHES AND REDEFINES THE PROFILE OF THE TULLE COMPOSITION, ALLOWING MANY VARIATIONS. THE SHAPES AND VOLUMES HAVE BEEN REVISITED, TO CREATE FUNCTIONAL COMPOSITIONS TO SUIT EVERY NEED

TULLE, UN MEUBLE AVEC GORGE STRUCTURELLE PLATE ET FAÇADES PLATES AVEC BORD INCLINÉ, EXTRÊMEMENT PRATIQUE ET FONCTIONNEL. LE CÔTÉ DE FINITION DE 1,2 CM D'ÉPAISSEUR FINIT ET REDÉFINIT LE PROFIL DE LA COMPOSITION EN TULLE, PERMETTANT DE NOMBREUSES COMBINAISONS. LES FORMES ET LES VOLUMES SONT RÉINTERPRÉTÉS, EN OFFRANT DES SOLUTIONS DE COMPOSITION ET FONCTIONNELLES À TOUTE EXIGENCE

TULLE IST MIT SEINER FLACHER KEHLELEISTE UND DEN FLACHEN FRONTEN MIT SCHRÄGER KANTE EIN ÄUSSERST UNKOMPLIZIERTES UND FUNKTIONALES MÖBELSTÜCK. DIE 1,2 CM DICKE VERARBEITENDE SEITEN VEREDELN UND DEFINIEREN DAS PROFIL DER TELLEZUSAMMENSETZUNG NEU UND ERLAUBEN VIELE VARIATIONEN. DIE FORMEN UND DIE VOLUMEN WERDEN NEU INTERPRETIERT UND BIETET NUN VIELFÄLTIG KOMBINIERBARE UND FUNKTIONELLE LÖSUNGEN FÜR JEDEN BEDARF

TULLE, UN MUEBLE CON GOLA ESTRUCTURAL PLANA Y FRENTE PLANOS CON CANTO INCLINADO, SUMAMENTE CÓMODO Y FUNCIONAL. EL LADO DE ACABADO DE 1,2 CM DE GROSOR ACABA Y REDEFINE EL PERFIL DE LA COMPOSICIÓN DE TUL, PERMITIENDO MUCHAS VARIACIONES. LAS FORMAS Y LOS VOLÚMENES RECIBEN NUEVAS INTERPRETACIONES, OFRECIENDO SOLUCIONES COMPOSITIVAS Y FUNCIONALES PARA CUALQUIER NECESIDAD

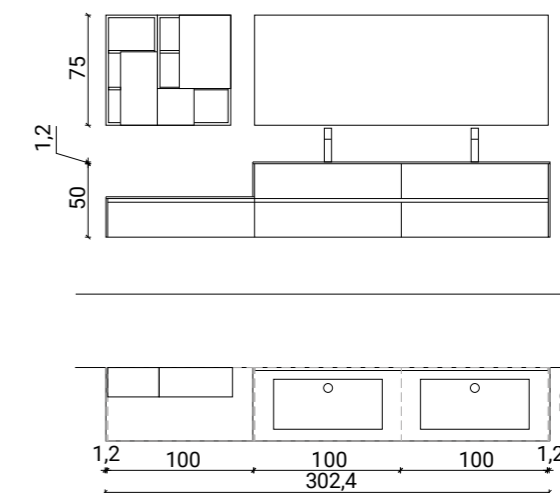

T-01

NODATO CANYON E HPL CALYPSO 435. TOP HPL CALYPSO 435 CON VASCA INTEGRATA "HHH5", SPECCHIO FILO CON ILLUMINAZIONE PERIMETRALE

NODATO CANYON AND HPL CALYPSO 435. HPL CALYPSO 435 TOP WITH "HHH5" INTEGRATED BASIN, FILO MIRROR WITH PERIMETRAL LIGHTING

NODATO CANYON ET HPL CALYPSO 435. PLAN DE TOILETTE EN HPL CALYPSO 435 AVEC VASQUE INTÉGRÉE "HHH5". MIROIR FILO AVEC ÉCLAIRAGE PÉRIMÉTRIQUE

NODATO CANYON UND HPL CALYPSO 435. WASCHTISCHPLATTE HPL CALYPSO 435 MIT INTEGRIERTEM BECKEN "HHH5", SPIEGEL MIT PERIMETRALEN-LED MOD. FILO

NODATO CANYON Y HPL CALYPSO 435. ENCIMERA DE HPL CALYPSO 435 CON CUBA INTEGRADA "HHH5". ESPEJO FILO CON ILUMINACIÓN EN EL PERÍMETRO



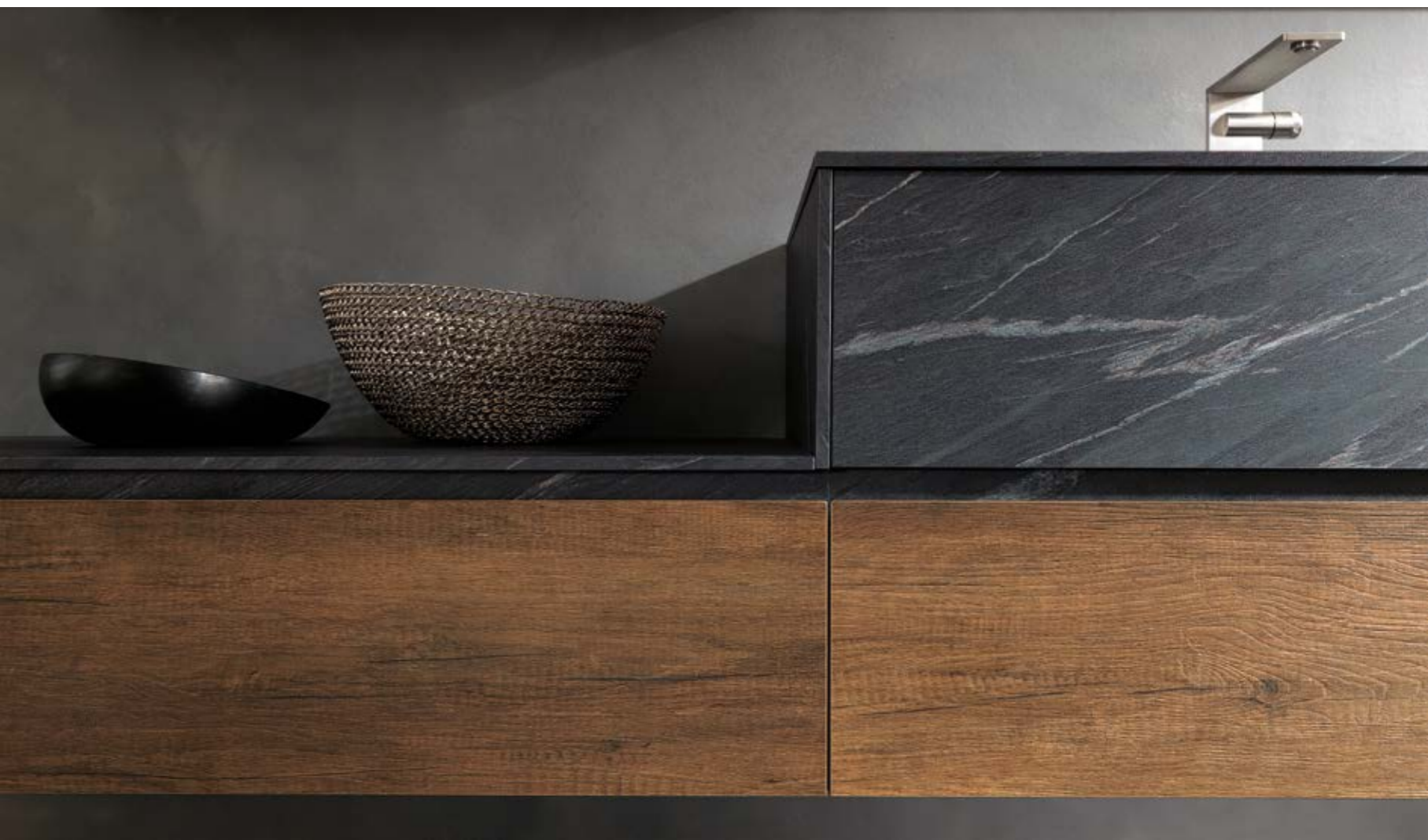



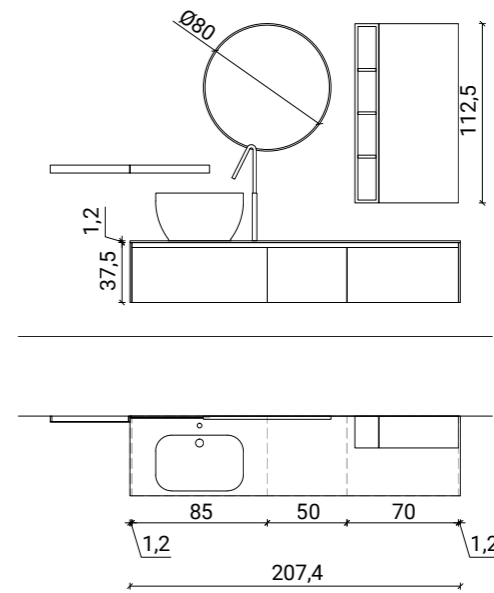

T-02

IMPIALLACCIATO NORDICO CAFFÈ E LACCATO GIADA OPACO. TOP NORDICO CAFFÈ CON LAVABO LADY IN TECNORIL, SPECCHIO MOON

NORDICO CAFFÈ VENEREED AND GIADA MAT LACQUERED. NORDICO CAFFÈ TOP WITH TECNORIL LADY BASIN, MOON MIRROR

PLACAGE CHÊNE NORDICO CAFFÈ ET LACQUÉE GIADA MAT. PLAN DE TOILETTE NORDICO CAFFÈ AVEC LAVABO LADY EN TECNORIL. MIROIR MOON

NORDICO CAFFÈ EICHE FURNIERT UND GIADA MATT LACKIERT. WASHTISCHPLATTE NORDICO CAFFÈ MIT BECKEN MOD.LADY TECNORIL. SPIEGEL MOD.MOON

CHAPA DE ROBLE NORDICO CAFFÈ Y LACADO GIADA MATE. ENCIMERA DE NORDICO CAFFÈ CON CUBA LADY DE TECNORIL. ESPEJO MOON







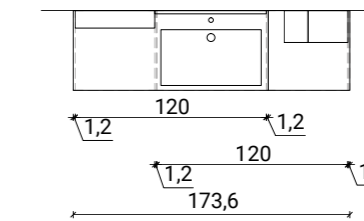
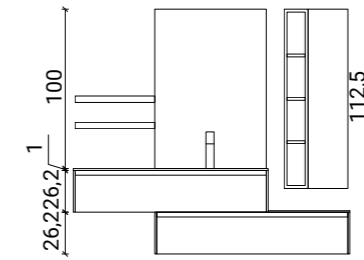

T-03

SKIN GRIGIO E BLU MOBY OPACO. TOP IN GRES PIETRA DI SAVOIA ANTRACITE CON VASCA INTEGRATA "GFF5", SPECCHIO FILO CON LAMPADA METRO

SKIN GRIGIO AND BLU MOBY MAT LACQUERED. GRES PIETRA DI SAVOIA TOP WITH "GFF5" INTEGRATED BASIN, FILO MIRROR WITH METRO LAMP

SKIN GRIGIO ET BLU MOBY MAT. PLAN DE TOILETTE EN GRES PIETRA DI SAVOIA ANTRACITE AVEC VASQUE INTÉGRÉE "GFF5". MIROIR FILO AVEC LAMPE METRO

SKIN GRIGIO UND BLU MOBY MATT LACKIERT. WASCHTISCHPLATTE GRES PIETRA DI SAVOIA ANTRACITE MIT INTEGRIERTEM BECKEN "GFF5". SPIEGEL MOD. FILO UND LAMPE MOD. METRO

SKIN GRIGIO E BLU MOBY. ENCIMERA DE GRES PIETRA DI SAVOIA ANTRACITE CON CUBA INTEGRADA "GFF5". ESPEJO FILO CON LAMPARA METRO





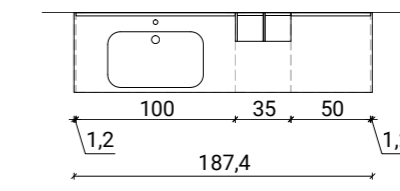
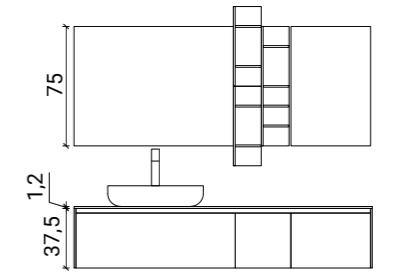

T-04

IMPIALLACCIATO EUCALIPTO AFFUMICATO CON PARTICOLARI LACCATI NERO OPACO. TOP GRES OSSIDO NERO CON LAVABO ELITE NERO OPACO. SPECCHIO PROFILO ALLUMINIO CON LAMPADA CLIO SLIM

EUCALIPTO AFFUMICATO
VENEREED WITH NERO MAT
LACQUERED DETAILS. GRES
OSSIDO NERO TOP WITH BLACK
MAT ELITE BASIN. ALUMINIUM
PROFILE MIRROR WITH CLIO SLIM
LAMP

EUCALIPTO AFFUMICATO
FURNIERT MIT DETAILS
NERO MATT LACKIERT.
WASCHTISCHPLATTE GRES OSSIDO
NERO MIT BECKEN MOD.ELITE
SCHWARTZ. SPIEGEL MIT ALU-
PROFIL MIT LAMPE MOD.CLIO SLIM

PLACAGE EUCALIPTO AFFUMICATO
AVEC DÉTAILS NERO MAT. PLAN
DE TOILETTE EN GRES OSSIDO
NERO AVEC LAVABO À POSER ELITE
NOIR MAT. MIROIR AVER PROFILS
EN ALUMINIUM AVEC LAMPE CLIO
SLIM

CHAPA DE EUCALIPTO
AFFUMICATO CON DETALLES NERO
MATE. ENCIMERA DE GRES OSSIDO
NERO CON CUBA ELITE NEGRA
MATE. ESPEJO CON PERFILES DE
ALUMINIO Y LAMPARA CLIO SLIM





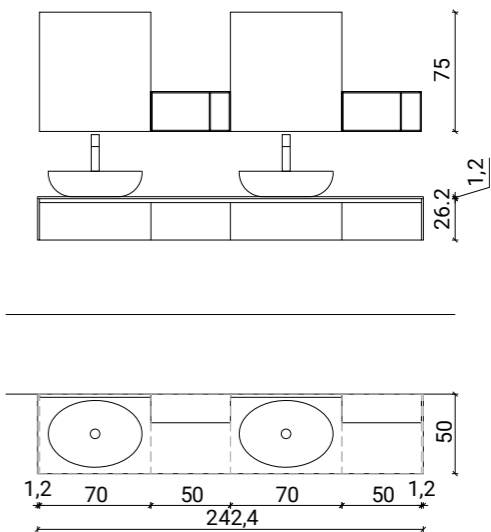

T-06

HPL PORFIDO 119, TOP HPL PORFIDO 119 CON SOFTLY, SPECCHIO E LAMPADA FILO

HPL PORFIDO 119, HPL PORFIDO 119 TOP WITH SOFTLY BASIN, MIRROR AND LAMP MOD. FILO

HPL PORFIDO 119, PLAN DE TOILETTE EN HPL PORFIDO 119 AVEC VASQUE À POSER SOFTLY, MIROIR ET LAMPE MOD. FILO

HPL PORFIDO 119, WASCHTISCHPLATTE HPL PORFIDO 119 MIT WASCHTISCH SOFTLY, SPIEGEL UND LAMPE FILO

HPL PORFIDO 119, ENCIMERA DE HPL PORFIDO 119 CON CUBA SOFTLY, ESPEJO Y LAMPARA FILO







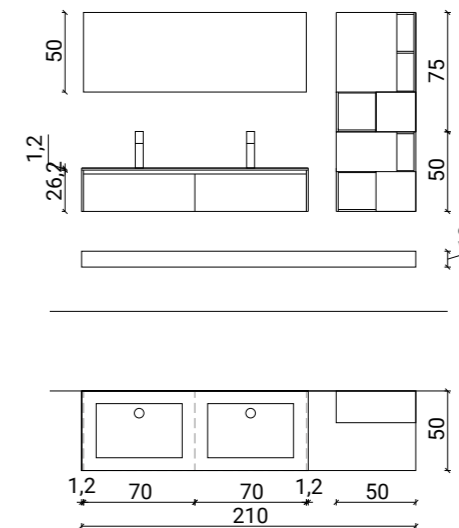

T-07

HPL ROVERE CASTORO 301 E LACCATO BIANCO OPACO, TOP IN TECNORIL CON VASCHE "AFF5" E TOP IN HPL ROVERE CASTORO 301. SPECCHIO FILO

HPL ROVERE CASTORO 301 AND MATT BIANCO LACQUERED, TECNORIL TOP WITH "AFF5" BASINS AND HPL ROVERE CASTORO 301 TOP. MIRROR FILO

HPL ROVERE CASTORO 301 ET LAQUÉ BIANCO MAT, PLAN DE TOILETTE EN TECNORIL AVEC VASQUES "AFF5" ET EN HPL ROVERE CASTORO 301. MIROIR FILO

HPL ROVERE CASTORO 301 UND BIANCO MATT LACKIERT, WASCHTISCHPLATTE TECNORIL MIT "AFF5" BECKEN UND PLATTE AUS HPL ROVERE CASTORO 301. SPIEGEL FILO

HPL ROVERE CASTORO 301 Y LACADO BIANCO MATE, ENCIMERAS DE TECNORIL CON CUBA "AFF5" Y DE HPL ROVERE CASTORO 301. ESPEJO FILO







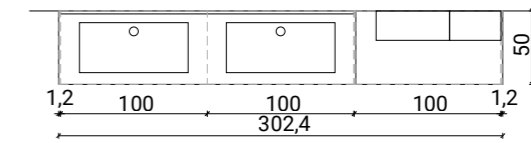
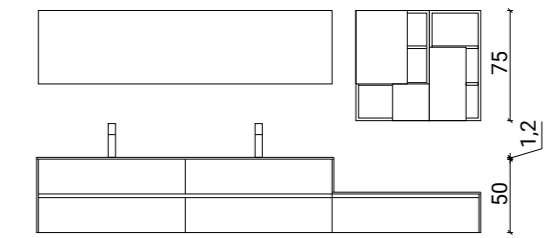

T-12

NODATO LONDRA E LACCATO BIANCO OPACO, TOP IN TECNORIL CON VASCHE "AHH5," SPECCHIO FILO CON ILLUMINAZIONE PERIMETRALE

NODATO LONDRA AND BIANCO MATT LAQUERED, TECNORIL TOP WITH "AHH5" INTEGRATED BASINS, FILO MIRROR WITH PERIMETRAL LIGHTING

NODATO LONDRA ET LAQUÉE BIANCO MAT, PLAN DE TOILETTE EN TECNORIL AVEC VASQUES "AHH5", MIROIR FILO AVEC ÉCLAIRAGE PÉRIMÉTRIQUE

NODATO LONDRA UND BIANCO MATT LACKIERT, WASCHTISCHPLATTE TECNORIL MIT INTEGRIERTEM BECKEN "AHH5".SPIEGEL MOD.FILO

NODATO LONDRA Y LACADO BIANCO MATE, ENCIMERA DE TECNORIL CON CUBAS "AHH5", ESPEJO FILO CON ILUMINACIÓN EN EL PERÍMETRO







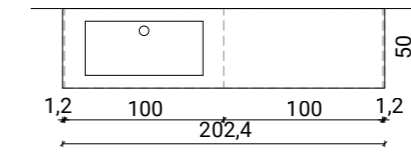
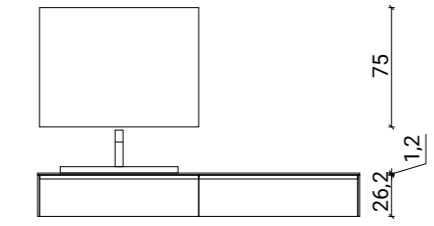

T-16

NORDICO CAFFÈ, PENSILI LACCATI BIANCO OPACO, TOP NORDICO CAFFÈ CON LAVABO IN TECNORIL REGOLO, SPECCHIO FILO

NORDICO CAFFÈ, WALL ELEMENTS
MATT BIANCO LACQUERED,
NORDICO CAFFÈ TOP WITH
TECNORIL BASIN REGOLO,
MIRROR FILO

NORDICO CAFFÈ, ÉLÉMENTS
HAUTS LACQUÉE BIANCO MAT,
PLAN DE TOILETTE EN NORDICO
CAFFÈ AVEC LAVABO EN TECNORIL
REGOLO, MIRROIR FILO

NORDICO CAFFÈ,
WANDHÄNGESCHRÄNK
BIANCO MATT LACKIERTE,
WASCHTISCHPLATTE NORDICO
CAFFÈ MIT TECNORIL BECKEN
REGOLO, SPIEGEL FILO

NORDICO CAFFÈ, COLGANTES
LACADOS BIANCO MATE,
ENCIMERA DE NORDICO CAFFÈ
CON CUBA EN TECNORIL REGOLO,
ESPEJO FILO







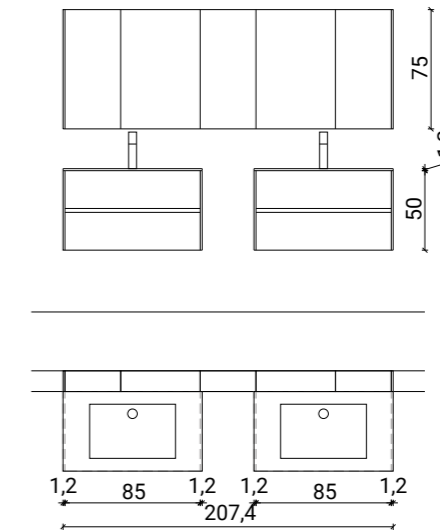

T-17

NORDICO CIOCCOLATO E NATURALE, LAVABI BOX BIANCO LUCIDO, SPECCHI CONTENITORI

NORDICO CIOCCOLATO AND
NATURALE, WHITE GLOSS BOX
BASINS, MIRRORS CABINET

NORDICO CIOCCOLATO ET
NATURALE, CONSOLES BOX
BLANC BRILLANT, MIROIRS AVEC
CONTENEURS

NORDICO CIOCCOLATO UND
NATURALE, WASCHTISCHPLATTE
BOX WEISS HOCHGLANZ,
SPIEGELSCHRÄNKE

NORDICO CIOCCOLATO Y
NATURALE, CONSOLAS BOX
BLANCO BRILLANTE, ESPEJOS
CONTENEDORES





ACCESSORI & FINITURE
MODELLO TULLE



ACCESSORI STRIKE

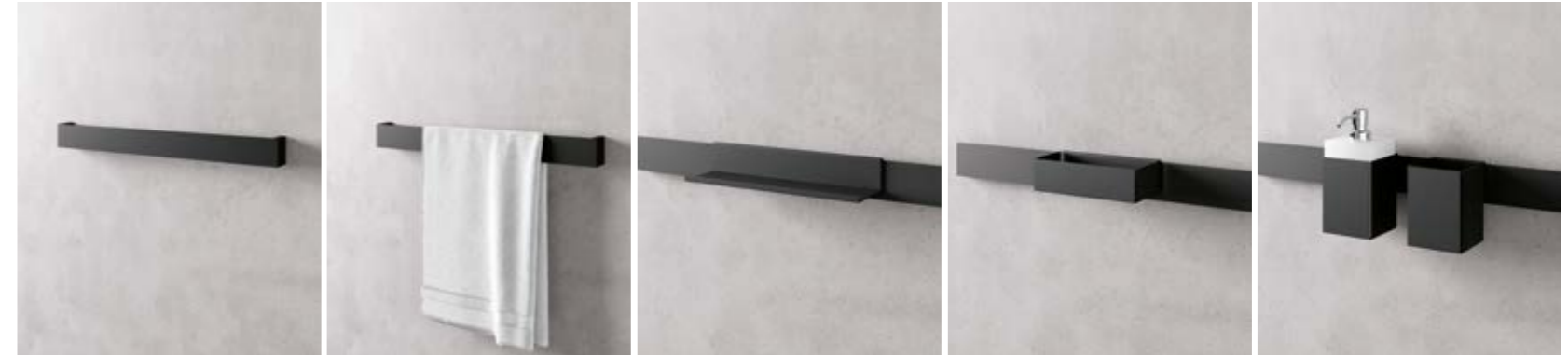

BARRA

PORTASALVIETTE

MENSOLA

VASCHETTA

BICCHIERE - PORTASAPONE



PORTAPHON

PORTASMARTPHONE

ACCESSORI TRATTO

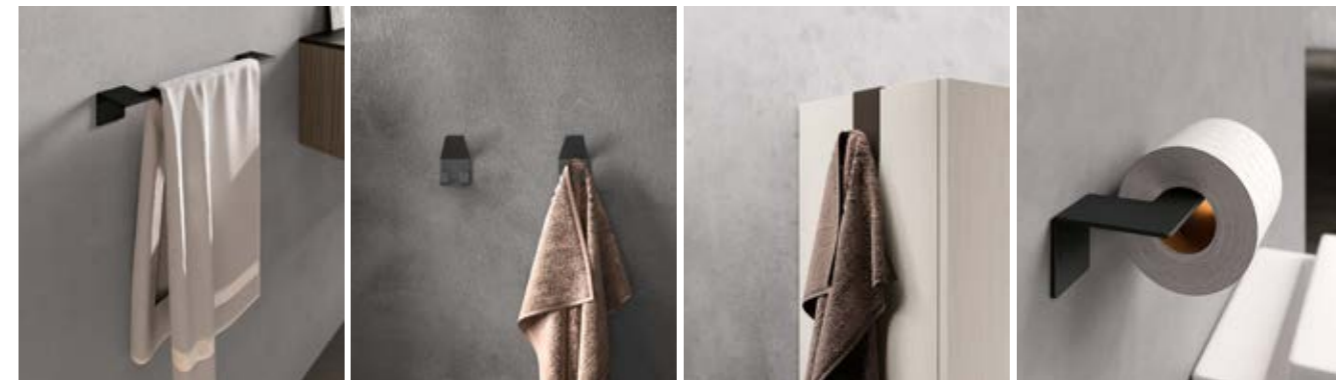

PORTASALVIETTE

APPENDINO

APPENDIABITO

PORTAROTOLO

Finiture

Finishes
Finitions
Ausführungen
Acabados

Laccato opaco/lucido

Matt/gloss lacquered / Lacquée mat et brillant
Matt oder glänzend lackiert / Lacado mate y brillo



Finiture

Finishes
Finitions
Ausführungen
Acabados

Laccato metal

Metal lacquered / Lacqué Metal
Metal lackiert / Lacado Metal



Bimelaminico skin

Bimelaminated Skin / Bi-mélatiné Skin
Bimelamin Skin / Bi-melamina Skin



Bimelaminico syncro

Bimelaminated Syncro / Bi-mélatiné Syncro
Bimelamin Syncro / Bi-melamina Syncro



Finiture

Finishes
Finitions
Ausführungen
Acabados

Legni

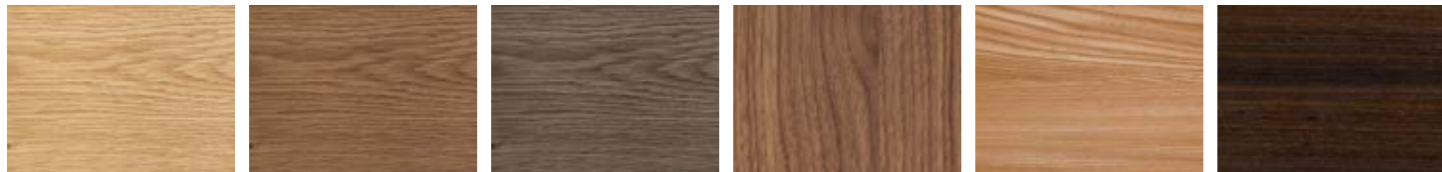

ROVERE NORDICO NATURALE ROVERE NORDICO CIOCCOLATO ROVERE NORDICO CAFFÈ NOCE CANALETTO OLMO EUCALIPTO AFFUMIGATO

Rovere fiammato decapé

Decapé Fiammato Oak / Chêne Fiammato Decapé
Decapé Fiammato Eiche / Roble Fiammato Decapé



BIANCO PORO SCURO JUTA PORO BIANCO CANAPA PORO BIANCO FINESTRA PORO BIANCO POLVERE PORO BIANCO AVIO PORO BIANCO

Rovere fiammato tinto

Fiammato Oak / Chêne Fiammato Teinté
Fiammato Eiche / Roble Fiammato



AGATA CASTAGNA CORDA GRANO QUARZO TARTUFO

Terre

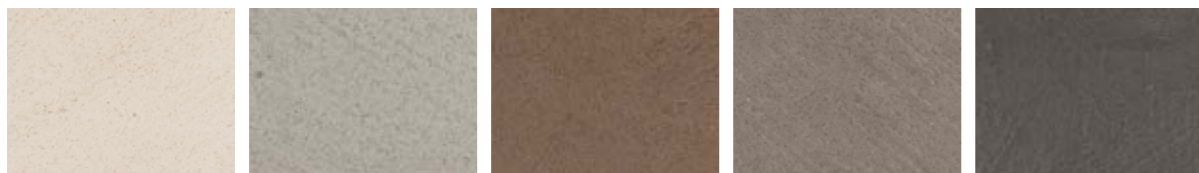

PERLESCENTE MASTICE OMBRA ROMA VITE

Finiture

Finishes
Finitions
Ausführungen
Acabados

Hpl unicolor



STATUARIO S. T. 439 CEMENTO 143 OLMO SCURO 303 OLMO BIONDO 134 ROVERE MONET 423 ROVERE TEXAS 306 ROVERE VERSAILLES 418

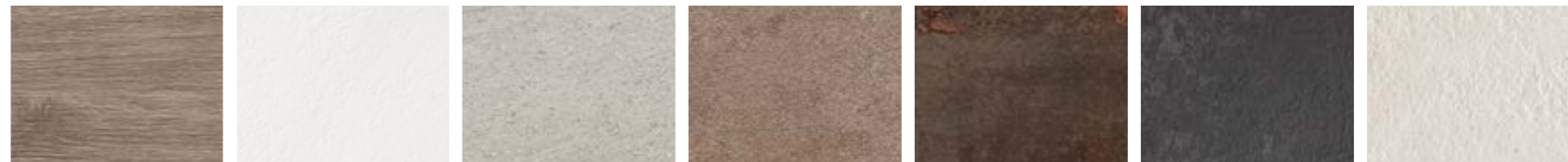

ROVERE CASTORO 301 SASSO 139 BASALTO 403 PORFIDO 119 OSSIDO 146 ARDESIA 145 MALTA BIANCA 430



MALTA GRIGIA 431 MALTA CANAPA 432 ANTIQUE BOTTICINO 410 CUMA DARK 428 CALYPSO 435 TOBACCO 440



IMPERO 438

Fenix



GRIGIO EFESO 725 VERDE COMODORO 750 BLU FES 754



BIANCO 32 NERO 720 BIBER 717 BROMO 724 GRIGIO 718

CATALOGUE PLANNIG
Maurizio Poletto

R. & S.
Archeda Srl

DESIGN E A.D.
Dario Poles

GRAPHIC DESIGN CATALOGO
Graphosds

FOTOGRAFIA
Gabriotti Fotografi

FOTOLITO E STAMPA
graficheitalprint.it

OTTOBRE 2022

Archeda, al fine di migliorare le caratteristiche tecniche e qualitative della sua produzione, si riserva di apportare, anche senza preavviso, tutte le modifiche che si rendessero necessarie.

To improve the technical and the qualitative characteristics of the production, Archeda reserves the right to make all the suitable modifications without previous notice.

A fin daméliorer les caractéristiques techniques et qualitatives de sa production, la société Archeda se réserve le droit d'apporter, même sans preavis, toutes les modifications qui seront jugées nécessaires.

Um technische und qualitative Merkmale der Produktion zu verbessern, behält sich Archeda vor, alle nötige Abänderungen, ohne Avisierungen, vorzunehmen.

Archeda, a fin de mejorar las características técnicas y cualitativas de su producción, se reserva el derecho de aportar, incluso sin previo aviso, todas las modificaciones necesarias.

